



The natural way



SISSEL[®] QUALITY PRODUCTS

Innovative products for Healthy Moving,
Healthy Sitting, Well-Being, and Healthy Sleeping

2026

[sissel.com](https://www.sissel.com)

Table of Contents

04 | 05 SISSEL Moving Together

06 | 09 SISSEL ACADEMY

Follow us on:

 [sissel.international](https://www.facebook.com/sissel.international)

 [@sissel.international](https://www.instagram.com/sissel.international)

 [SISSEL GmbH](https://www.linkedin.com/company/sissel-gmbh)

 Information videos on
[youtube.com/SisselCom](https://www.youtube.com/SisselCom)



Size



Material



Colour



Natural weight fluctuations



Heat application



Cold application



Heat & cold application



Heating in the microwave



Heating in the oven



Heating in the pot

Healthy Moving

SPINEFITTER by SISSEL

12 | 13 SPINEFITTER by SISSEL System

14 | 15 SPINEFITTER by SISSEL Possible Applications

16 | 17 SPINEFITTER by SISSEL,
SPINEFITTER by SISSEL Pink Hero Edition

NEW

18 | 19 SPINEFITTER by SISSEL Trigger Tool,
SPINEFITTER by SISSEL Linum | Linum Pro

20 | 21 SPINEFITTER by SISSEL Mini & Multi Extension Kit

22 | 23 SPINEFITTER by SISSEL Accessories

24 | 25 SPINEFITTER by SISSEL Junior

NEW

Fitness

27 SISSEL SECUREMAX Ball

28 | 29 Accessories for Gym Balls, SISSEL Gym Ball Cover

30 | 31 SISSEL Fitband Plus & SISSEL Fitband Essential,
SISSEL Fun & Active Band, SISSEL Exercise Loop

32 | 33 SISSEL OCTOCORE,
SISSEL X-Tension Ring Set, SISSEL X-Tension Band

34 | 35 SISSEL Fit-Tube, SISSEL Door Anchor,
SISSEL Sport Swing Plus

36 | 37 SISSEL Gym Mat, SISSEL Gym Mat Professional,
SISSEL Gym Mat Plus, Accessories

38 | 39 SISSEL EPIFLOW Kinesiology Tape,
SISSEL Kinesiology Tape, SISSEL Knee Roller

NEW

Balance

- 40 | 41 SISSEL FIT-Dome Sport
- 42 | 43 SISSEL Spiky Dome, SISSEL Balancefit, SISSEL Balancefit Pad & SISSEL Balancefit Pad Large
- 44 | 45 SISSEL Balance Board Plus, SISSEL Balance Board Dynamic, SISSEL Step-Fit

Fascial Release

- 46 | 47 SISSEL Myofascia Roller, SISSEL Myofascia Ball, SISSEL Myofascia Double Ball
- 48 | 49 SISSEL Mobilyzor Set, SISSEL Vitalyzer, SISSEL Massage Roller

Yoga

- 50 | 51 SISSEL Yoga Relax Cushion Fresh Green, SISSEL Yoga Block, SISSEL Yoga Belt, SISSEL Yoga Socks
- 52 | 53 SISSEL Yoga Mat, SISSEL Terra Yoga Mat, SISSEL Pilates & Yoga Mat

Pilates

- 54 | 55 SISSEL Pilates Circle, SISSEL Pilates Circle Compact, SISSEL Pilates Core Trainer
- 56 | 57 SISSEL Pilates Roller, SISSEL Pilates Roller Pro, SISSEL Pilates Roller Pro Soft, SISSEL Intense Roller
- 58 | 59 SISSEL Pilates Roller Head Align Dynamic, SISSEL Pilates Roller Center, SISSEL Pilates Toning Ball, SISSEL Pilates Soft Ball
- 60 | 61 SISSEL Pilates Band, SISSEL Workout Gloves, SISSEL Pilates One Toe Socks, SISSEL Pilates Socks

Hand Therapy

- 62 | 63 SISSEL Press-Ball, SISSEL Press-Egg, SISSEL Finger Exerciser
- 64 | 65 SISSEL Twin Grip, SISSEL Putty

Healthy Sitting

- 68 | 69 SISSEL SITFIT Plus, SISSEL SITFIT, Cover
- 70 | 71 SISSEL Sit Special 2 in 1, SISSEL Sit Standard & Colour, SISSEL Sit Air
- 72 | 73 SISSEL DorsaBack & -Pad, SISSEL DorsaBack-Car
- 74 | 75 SISSEL Sit Ring, SISSEL Back, SISSEL Tour

Well-Being

Hot-Cold Therapy

- 78 | 79 SISSEL Hot-Cold Pearl Pack, SISSEL Pack
- 80 | 81 SISSEL Hot-Cold-Soft-Pack, SISSEL Cold Therapy Compression, SISSEL Therm, SISSEL Soft Touch Pro
- 82 | 83 SISSEL Comfy Belt, SISSEL Hydrotemp, SISSEL Vinotherm, SISSEL Aroma Neck Roll
- 84 | 85 SISSEL Linum Classic & Anatomic, SISSEL Linum Cervico
- 86 | 87 SISSEL Cherry, SISSEL Cherry Heat Belt, SISSEL Balu

Massage

- 88 | 89 SISSEL Fit-Roller
- 90 | 91 SISSEL Spiky Twin Roller, SISSEL Spiky-Ball
- 92 | 93 SISSEL Neck Relax, SISSEL Acupressur Mat
- 94 | 95 SISSEL Funmassager, SISSEL Mobilyzor, SISSEL Massage Roller

Inversion for Back Problems

- 96 | 97 SISSEL Hang Up

Healthy Sleeping

- 100 | 101 SISSEL Orthopaedic Pillows
- 102 | 103 SISSEL Classic, SISSEL Classic Plus
- 104 | 105 SISSEL Soft, SISSEL Soft Plus, SISSEL Soft Deluxe
- 106 | 107 SISSEL Compact Pillow, SISSEL Soft Bambini, SISSEL Soft Curve
- 108 | 109 SISSEL Palea, SISSEL Panicore, SISSEL Buchi, SISSEL Buchi Soft
- 110 | 111 SISSEL Medi Support, SISSEL Comfort
- 112 | 113 SISSEL Venosoft, SISSEL Venosoft Balance, SISSEL Venosoft

NEW

Moving Together – for Better Health and Quality of Life.

It all started with a neck pillow ...

The anatomically shaped SISSEL neck pillow was originally created in 1986 and quickly attracted the interest of professionals in therapy, nursing, and rehabilitation. Clinical studies also showed the positive effect of the pillow. To this day, this anatomical, effective shape has stood the test of time and has since formed the basis of our corporate philosophy. The unique shape of the original neck pillow is still reflected in the SISSEL logo today.

'The natural way' – our guiding principle and commitment to supporting our customers' health in a natural way, with a high-quality product portfolio designed to help maintain and promote well-being. Under the visionary leadership of Managing Directors Jens and Lars Friebel, the SISSEL portfolio has evolved into a diverse, health-focused range of products, reflected in the different product worlds of our SISSEL Healthcare Circle.



Jens and Lars Friebel shape the dynamic and forward-looking leadership of SISSEL GmbH.

Our customers

Healthcare professionals around the world trust and rely on our products. Physiotherapists, doctors, trainers, and coaches rely on the quality and performance of 'Made by SISSEL' in their daily work. That's why we offer tailored solutions for a wide range of applications.

SISSEL – proven quality since 1986

Convincing in every detail: for over 40 years, the SISSEL brand has stood for quality and customer satisfaction. Every product in our health range is carefully selected and manufactured to the highest quality standards.

Continuous innovation in product development, production processes and technologies, material selection, and our strong focus on sustainability and social responsibility form the foundation of our company.

- Production primarily in Europe
- Quality management system certified according to DIN EN ISO 13485:2021

5-year SISSEL guarantee

You can rely on SISSEL quality. That's why we offer a 5-year guarantee on the shape retention of all SISSEL orthopaedic neck pillows, as well as the SISSEL Soft Curve, SISSEL Buchi Soft, SISSEL Medi Support, SISSEL Sit Special 2 in 1, SISSEL Sit Ring, and SISSEL Back.



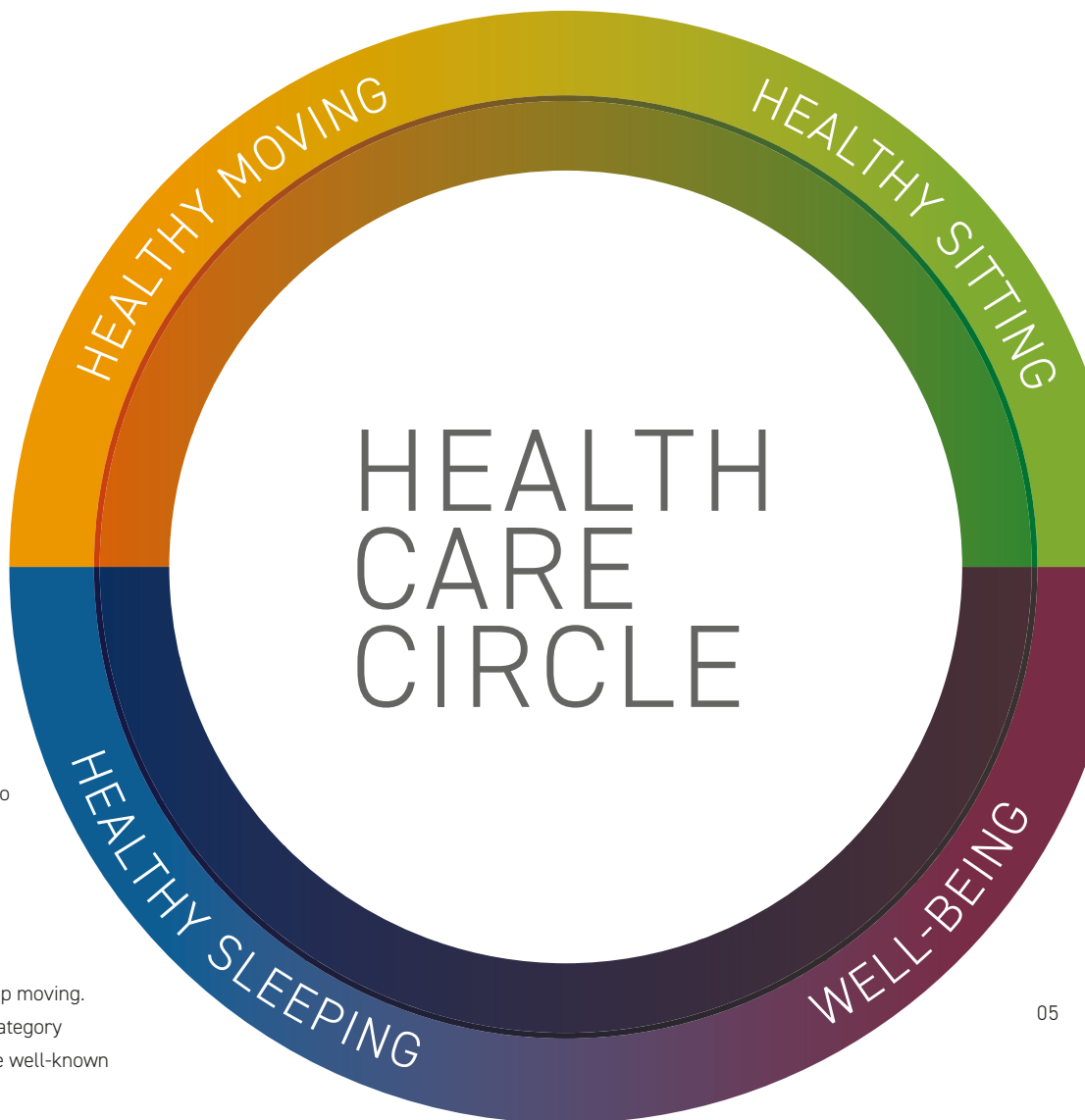

The SISSEL Healthcare Circle

The SISSEL Healthcare Circle represents our entire product portfolio and organises it into four key product areas, supporting a holistic approach to our health-focused range.

Healthy Moving

If you want to stay fit, you need to keep moving. Our products in the Healthy Moving category support an active lifestyle – led by the well-known SPINEFITTER by SISSEL.

Healthy Sitting

Nowadays, we spend much of our day sitting – often leading to a range of issues and discomfort. Our Healthy Sitting products provide effective support for better posture – including the SISSEL SITFIT.

Well-Being

Whether it's heat, cold, massage, or simply relaxation – here you'll find products designed to support your personal well-being.

Healthy Sleeping

Healthy sleep is the foundation of well-being in everyday life. We offer a wide range of products designed to support restful sleep – including our original neck pillow.

Many of our innovations have become classics over time. Products such as the SPINEFITTER by SISSEL are making a strong impact in the health and fitness industry worldwide. Thanks to our international partners, SISSEL products are now available in over 70 countries.

At SISSEL, we place great importance on sustainability

A key milestone in conserving resources is our new product packaging. The new design stands out for its clarity, Scandinavian character, and focus on what matters most.

- Climate-neutral natural cardboard (CO₂-neutral)
- Reduced use of colour (single-colour printing)
- Packaging from responsible sources (FSC-certified)
- No outer packaging required (suitable for direct shipping)
- Stylised usage illustration on the front



SISSEL ACADEMY

Education & Inspiration

The SISSEL ACADEMY was founded a decade ago and stands for first-class international fitness and rehabilitation educational programmes led by a global community of experienced Educators.

As Head of SISSEL ACADEMY, Nina Metternich devotes her time to establishing and developing the academy on an international level. Thanks to her many years of experience in therapy practice and further training, Nina Metternich can draw on in-depth knowledge from the fields of physiotherapy, osteopathy, and Pilates. This enables her to ensure that the trainers are educated at the highest level.

The ACADEMY's mission is to support the high-quality training of future Educators and to create exciting and purposeful new workshops for the fitness and health industry of tomorrow. The SISSEL ACADEMY offers high quality workshops in a stimulating and professional environment. The SISSEL ACADEMY workshops permit attendees to dive deeper into the anatomical correlations and core principles of the selected SISSEL product and includes exercise programmes to support individual and group training and rehabilitation. The courses contain a strong focus on practice-based knowledge, thus allowing specialists to directly implement their newly gained knowledge from the workshop in their personal training or therapy practice.

Each workshop includes a detailed workbook that can be used as a manual for professionals in their daily work. After successfully completing the workshop professionals will receive a SISSEL ACADEMY Certificate.

Deepen your skill set and get inspired by our dedicated workshop formats centred around the SPINEFITTER by SISSEL and brand new SISSEL product developments. Become part of our growing community of highly educated trainers and specialists.

We look forward to welcoming you to the SISSEL ACADEMY.



Scan the QR code for direct access to all SISSEL Academy workshops and webinars.



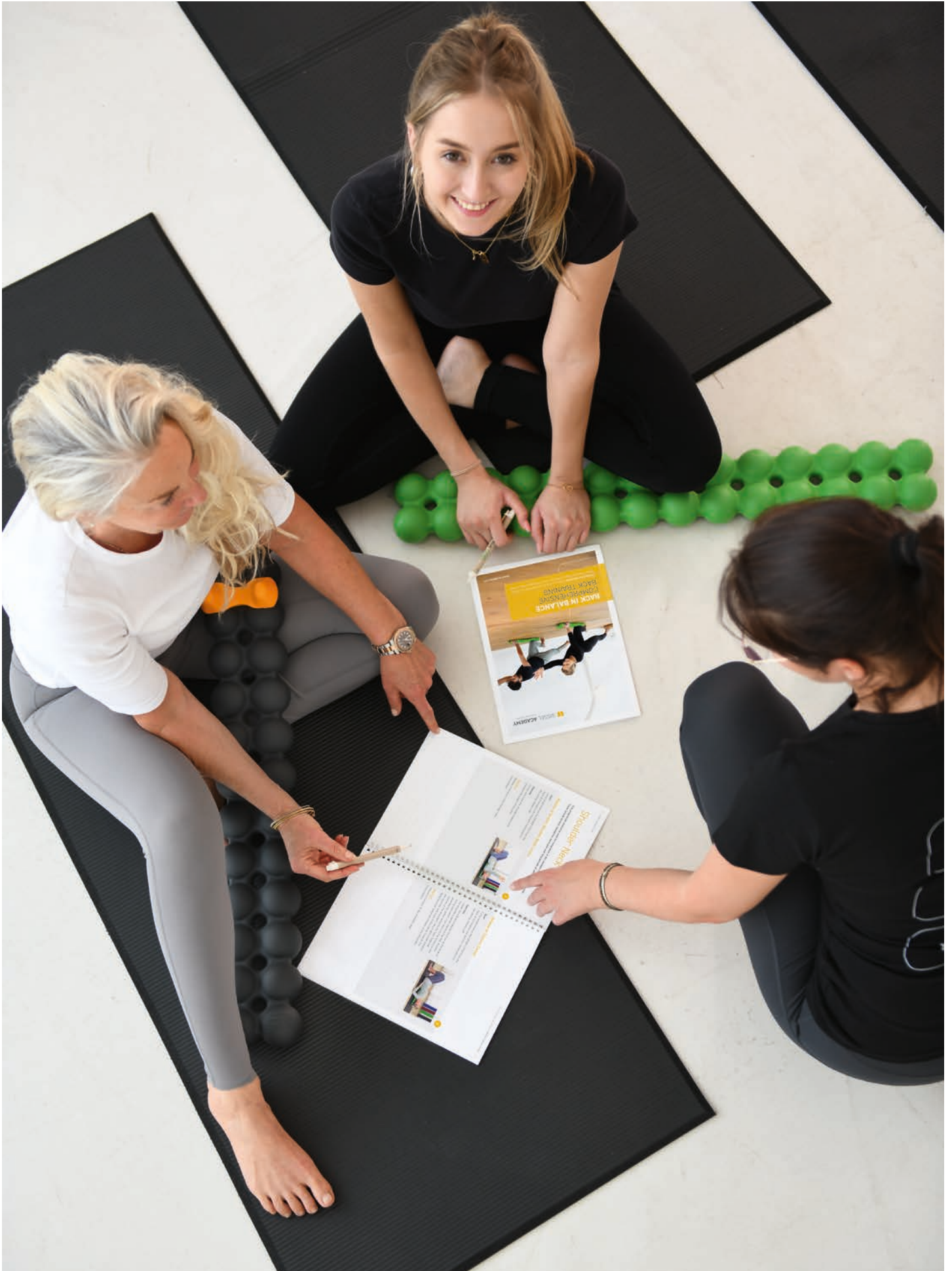

Our Workshops



Professional workshop: Back in Balance

Comprehensive back training – exercises with the SPINEFITTER by SISSEL

This 4-hour workshop, leading to certification as a 'Certified Professional Instructor', is specifically designed for physiotherapists, medical professionals, and trainers.

In this workshop, you will learn exercises for specific indications, understand their functional context, and work with structured exercise programmes. The workshop also covers anatomical principles, pathologies, therapeutic approaches, and practical guidance for working with your patients or participants.

08



Professional workshop: Functional training of the myofascial chains

Exercises with the SISSEL OCTOCORE

This 6-hour workshop, leading to certification as a 'Certified Professional Instructor', is specifically designed for physiotherapists, medical professionals, and trainers, and focuses on training functional muscle chains and engaging myofascial pathways.

In this workshop, you will work on training functional muscle chains and engaging myofascial pathways. A wide range of exercise variations enables you to address the entire body with each movement and effectively compensate for imbalances. The concept promotes functional training that provides new stimuli for your participants.



SISSEL ACADEMY

Education & Inspiration



09

Video course: SISSEL EPIFLOW

Learn about the versatile applications of EPIFLOW Tape in this practice-oriented course developed by experienced therapists. The innovative technique has proven to be particularly effective in the treatment of scar tissue, lymphatic congestion, and the mechanical relief of specific areas of the body.

In this video course, you will learn how the targeted application of EPIFLOW Tape can help activate the body's self-healing processes and relieve pain. You will not only gain an understanding of various pathologies and their underlying causes, but also explore individual treatment approaches.

You will receive valuable insights into the handling and application of taping techniques and will be able to apply them directly in your therapeutic practice. This 60-minute video course offers you the opportunity to expand your knowledge and further develop your practical skills in the field of modern therapy approaches.

Discover the SISSEL ACADEMY's specialised workshop formats



Scan the QR code to access upcoming workshops.

New workshop formats are continuously developed based on current medical research and practical experience.



Healthy Moving

Find everything you need for your equipment setup – whether for the gym, at home, or in a physiotherapy practice. Whether you're looking for a new fitness tool to bring fresh momentum to your training or high-quality products from the fields of yoga, balance, fitness, fascia training, or Pilates, you'll find a wide selection of innovative and proven products.

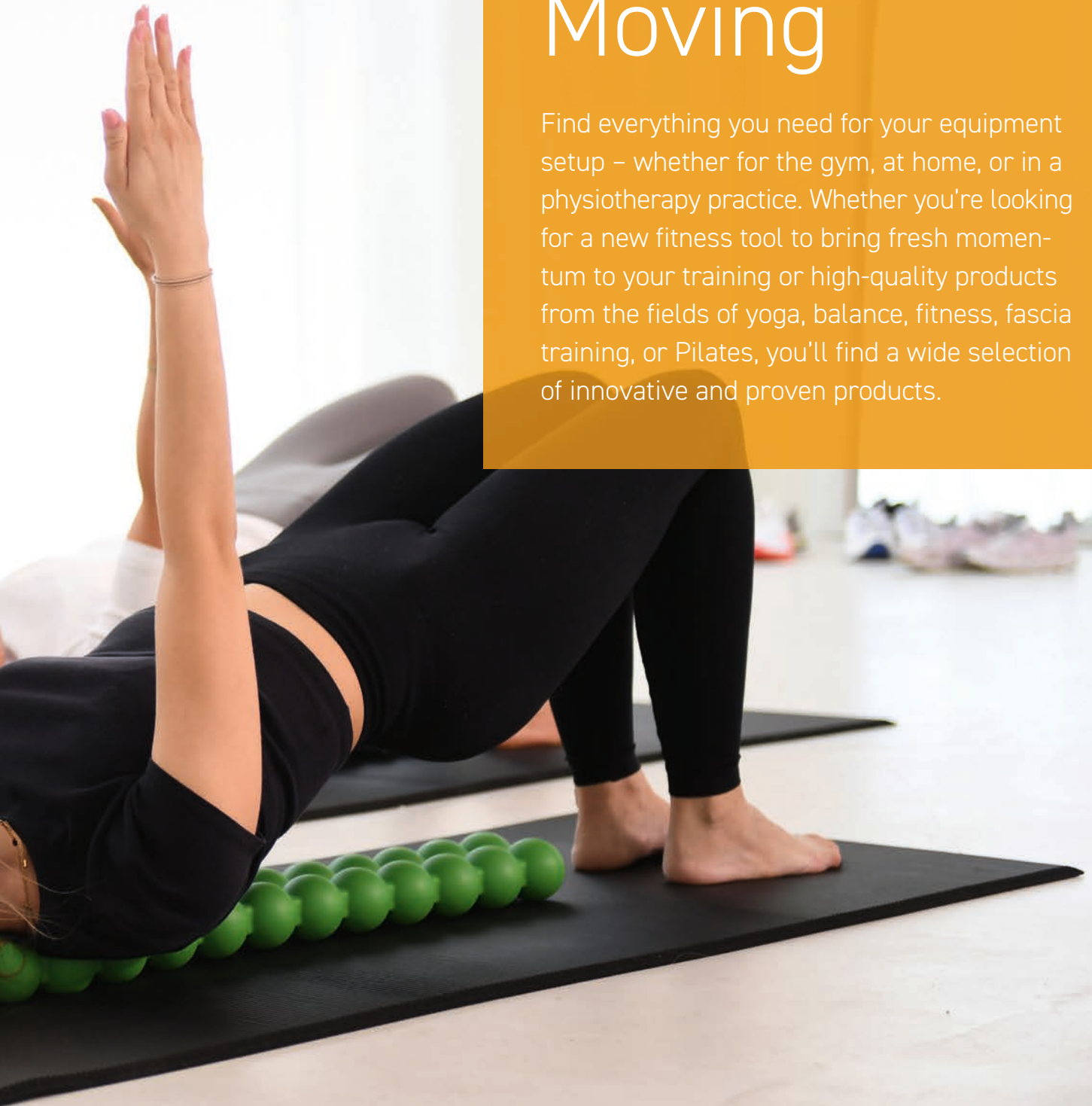

SPINEFITTER® by SISSEL® System

Effectively helps relieve pain in the back, neck, and shoulder region

As part of an internationally conducted study, it was examined to what extent a specially developed SPINEFITTER training programme improves the mobility of the thoracic spine, cervical spine, and shoulder joints, and contributes to the reduction of tension and pain in the neck and shoulder area. The results of the study show clear improvements in all areas analysed.



Read more about the Study of Effects in PT issue April 2022
or online at spinefitter.com



An Innovation by SISSEL®

An innovative, modular system for maximum application possibilities

Versatile and impactful training

The SPINEFITTER System was developed by an interdisciplinary team of physiotherapists, osteopaths, and Pilates trainers. Numerous exercises from the fields of Pilates and Yoga can be combined and supplemented with the SPINEFITTER. The SPINEFITTER loosens muscular tension, mobilises joints, and strengthens deep muscles. Thanks to targeted exercises, the SPINEFITTER helps to relieve pain effectively in the back, neck, and shoulder areas*.

The SPINEFITTER is made of PU integral foam and thanks to its unique shape, consisting of a 28 double-row ball structure, the SPINEFITTER enables comprehensive back training. The modular design of the system makes it easy to attach various add-ons and thanks to its excellent connection options, this effective training tool becomes a valuable treatment and relaxation aid. Versatile exercise options allow to train safely and effectively in the physiotherapy practice, studio, and at home.

Discover the SPINEFITTER System and learn why this multi-tool has quickly become a professional asset in the physiotherapy practices and self-treatment at home.

*Scan the QR code on the left to view a summary of the study.

SPINEFITTER by SISSEL Trigger Tool

The attachable module offers a simple way to autonomically release trigger points and hardenings along the spine most precisely, and, thus, contributing to pain relief.

Tip: Can also be combined with the SPINEFITTER Mini.



SPINEFITTER by SISSEL Multi Extension Kit

Expands the range of exercises and is perfect for people taller than 180 cm. Consists of the SPINEFITTER by SISSEL Mini and a Connector. The simple click system ensures a correct alignment of the Multi Extension Kit.



SPINEFITTER by SISSEL
Multi Extension Kit:
Mini with Connector

SPINEFITTER by SISSEL Linum & Linum Pro

The perfectly fitting SPINEFITTER cover with natural linseed filling can be used for heat application on the SPINEFITTER and comes in two versions: for use at home or for professional application.



SPINEFITTER
not included

OCS
SPINEFITTER
BACK IN BALANCE

SPINEFITTER – One Tool,



SPINEFITTER in therapy

Using the SPINEFITTER in your therapy opens up entirely new possibilities for the effective mobilisation of the spine and targeted treatment of the muscles around the shoulder joint.

Your patients will feel the difference immediately, enhancing body awareness and making newly gained mobility both visible and tangible. They quickly understand which muscles are activated to support spinal stability when working with the SPINEFITTER.

The SPINEFITTER can be used flexibly on a treatment table or on a mat, allowing it to be easily integrated into a wide range of therapeutic concepts.



In our SISEL ACADEMY workshops and webinars, experienced educators demonstrate the wide range of applications of the SPINEFITTER in therapeutic practice.



SPINEFITTER in group training

The SPINEFITTER is the ideal partner for your group training sessions. Users immediately feel its positive effect on the body. Through the direct feedback provided by the SPINEFITTER, individual corrections by the trainer are not required. Participants quickly recognise which muscles need to be activated and learn to perform movements more consciously.

The result: effective and noticeable mobilisation, as well as targeted release of tension within a group setting – all without the need for constant instruction. This makes the SPINEFITTER an ideal tool for efficient, safe, and modern group training.



Many Possibilities

SPINEFITTER in sport

Whether for warm-up, training, or rehabilitation, the SPINEFITTER is an ideal training tool for both amateur and professional athletes to release tension in a targeted way and prepare the body for physical demands. Its flexibility and the variety of exercises make it suitable for the requirements of a wide range of sports.

The SPINEFITTER has both a mobilising and activating effect. During the recovery phase, it supports tissue relaxation and helps relieve stressed muscles. This makes the SPINEFITTER an effective tool for enhancing performance, helping to prevent injuries, and supporting recovery as part of everyday training.



SPINEFITTER at home

Quick and easy back training with the SPINEFITTER – all from the comfort of your own home. Effectively address pain and discomfort in the back, neck, and shoulders while simultaneously mobilising your spine and strengthening your supporting musculature. The SPINEFITTER is your ideal training companion for everyday use.

A wide range of simple and effective exercises, available in video format, allows for individual and targeted training of the shoulders, neck, and back. Just a few minutes are enough to make a difference.



15

Free training videos

Easy-to-follow exercises and training programmes in video format help you perform all movements correctly. This makes the SPINEFITTER a reliable companion for health and well-being, supporting everyday use, prevention, treatment, and training – whether in therapy, during sport, or at home.



In twelve free online training videos, you will discover a wide range of exercises with the SPINEFITTER.

SPINEFITTER® by SISSEL®



The innovation for a healthy back

Thanks to its unique design the SPINEFITTER by SISSEL enables comprehensive back training. The paired ball structure enables the spinous processes to sink in, which, even in a simple supine position, achieves a positive effect on the muscular tissue adjacent to the spinal column. The small vertebral joints can be opened and, thus, one's mobility can be improved. The SPINEFITTER is an intuitive training device and can be used for exercises in the area of spinal gymnastics, Pilates, and Yoga. Intuitive handling and a quickly noticeable effect make the SPINEFITTER an ideal piece of equipment for regular training in the Pilates or fitness studio, in therapy, or at home.



- Innovative training device with 28 interconnected balls
- Intense, deep-impact pressure across the entire muscular and fascial tissue along the spine
- Improves joint mobility, supports a more upright posture, and increases athletic performance
- Ideal for proprioceptive and balance training
- Strengthens deep muscular tissue
- Available in four colours: anthracite, green, blue, purple red
- Incl. SPINEFITTER Carry Strap for comfortable transport on the back

Item	Description
800379	SPINEFITTER by SISSEL, blue
800387	SPINEFITTER by SISSEL, green
800392	SPINEFITTER by SISSEL, anthrazit
800397	SPINEFITTER by SISSEL, purple red
800826	SPINEFITTER by SISSEL Pink Hero Edition, incl. SPINEFITTER Sleeve
800386	Set of 10 blue incl. Coach Bag
800391	Set of 10 green incl. Coach Bag
800396	Set of 10 anthrazit incl. Coach Bag
800401	Set of 10 purple red incl. Coach Bag

16



approx. 84 x 12 x 6 cm



polyurethane



available in 5 colours



Discover our workshops on the SISSEL ACADEMY website



SPINEFITTER

BACK IN BALANCE
PINK HERO EDITION 

SPINEFITTER[®] by SISSEL[®] Pink Hero Edition

Supports rehabilitation following breast cancer surgery

Many breast cancer patients particularly appreciate working with the SPINEFITTER to address treatment-related limitations such as reduced mobility. This positive feedback inspired us to launch a limited edition of 10,008 SPINEFITTER PINK HERO EDITION units. Part of the proceeds from this Special Edition will be donated to charitable organisations that support breast cancer patients.

This training device, identical in shape and function to the original, is presented in a distinctive pink colour. Pink is internationally recognised as a symbol of solidarity in the fight against breast cancer – particularly through the Pink Ribbon campaign and 'Pinktober' (Breast Cancer Awareness Month in October). The aim is to raise public awareness of the condition, while supporting research and providing assistance to those affected.

Relieves symptoms:

- Restores shoulder mobility
- Stretches the anterior muscle chain
- Stimulates lymphatic flow, which is important for the healing process
- May contribute to pain relief
- Enhances body awareness
- May support mental health

Included: The SPINEFITTER Sleeve

Breast cancer patients who have recently undergone treatment are often more sensitive to touch and pressure. The soft terry cloth cover helps to reduce pressure during use of the SPINEFITTER.



Item	Description
800826	SPINEFITTER by SISSEL Pink Hero Edition, incl. SPINEFITTER Sleeve



SPINEFITTER: approx. 84 x 12 x 6 cm
Sleeve: approx. 87 x 16 cm



SPINEFITTER: polyurethane
Sleeve: cotton



pink

SPINEFITTER[®] by SISSEL[®]

Trigger Tool



For the targeted relaxation of trigger points

It allows targeted, punctual pressure to be applied to trigger points, hardenings, and tensions. Consequently, the module offers a simple way to autonomously release trigger points and hardenings along the spine most precisely and, thus, contribute to pain relief. The shape of the Trigger Tool ensures symmetrical, constant pressure with the surface area of a therapeutic thumb. This allows pain points to be specifically released, blood circulation to be increased and the muscles to work evenly again.

- Pain reduction of trigger points
- Shape ensures a symmetrical, constant pressure
- Individual placement
- Optimum degree of hardness*
- Vary and regulate the intensity of the pressure using your own body weight



Thanks to the simple click system, the SPINEFITTER by SISSEL Trigger Tool can be effortlessly connected to the SPINEFITTER and SPINEFITTER Mini.

Item	Description
800415	SPINEFITTER by SISSEL Trigger Tool
800822	SPINEFITTER by SISSEL Trigger Tool incl. SPINEFITTER anthrazit



approx. 12 x 4,5 x 7 cm



polyurethane



melon yellow

YouTube

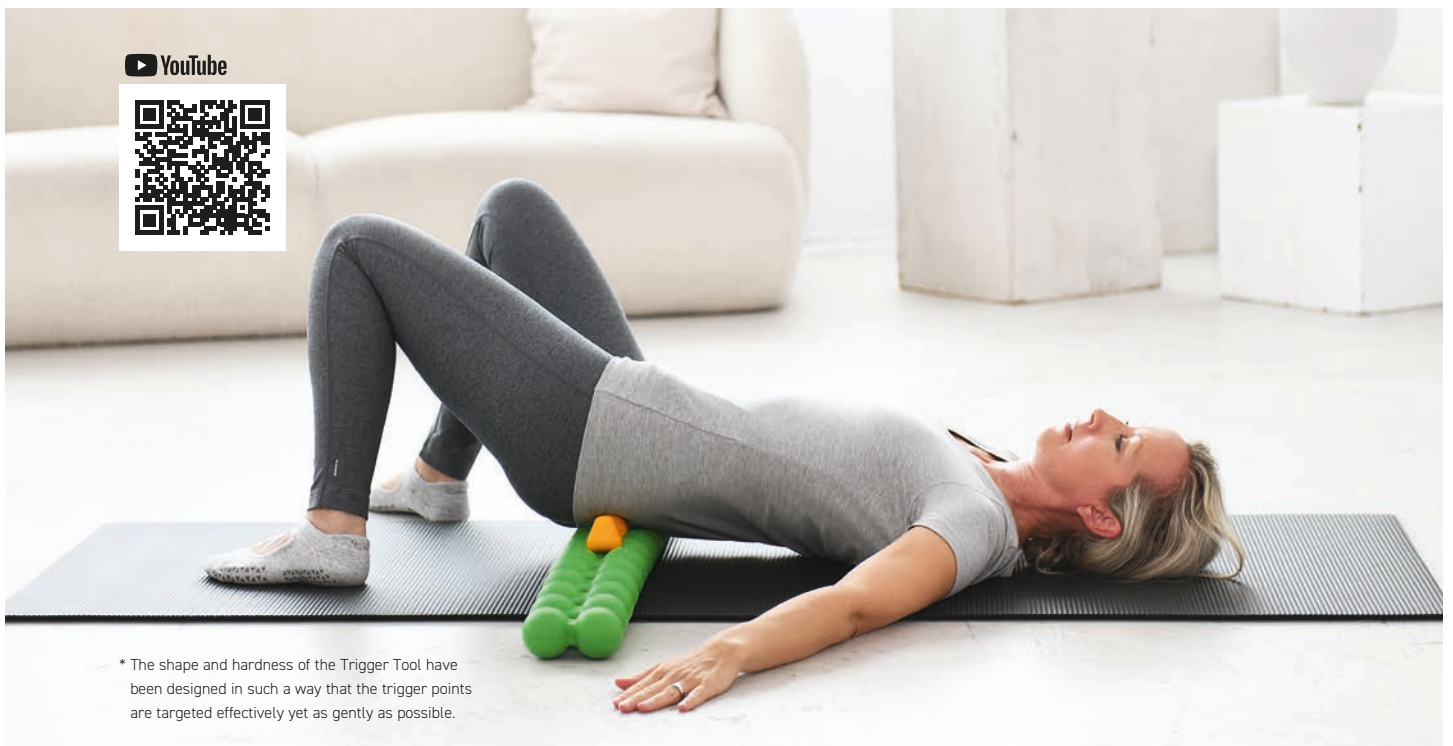

* The shape and hardness of the Trigger Tool have been designed in such a way that the trigger points are targeted effectively yet as gently as possible.

SPINEFITTER® by SISSEL®

Linum & Linum Pro



For the relaxation of the paravertebral muscles

The custom-fit SPINEFITTER cover with natural linseed filling can be used for heat application on the SPINEFITTER. The Linum/Linum Pro provides natural warmth along the entire spine and is ideal for relaxation, for loosening up the muscles before or after training, or for relieving pressure on the paravertebral muscles when training with the SPINEFITTER. Using the Linum/Linum Pro increases blood circulation along the spine and thus relieves pain.

- For heat application
- Ideal for relaxation or loosening up the muscles
- Filling: natural linseed filling
- Can be combined with the SPINEFITTER by SISSEL and Extension Kit

SPINEFITTER by SISSEL Linum Pro

- Specially developed for use in physiotherapy practices, Pilates and fitness studios – thanks to the wipeable and disinfectable surface

The hook-and-loop fasteners enable the simple insertion of the SPINEFITTER by SISSEL and the optional Extension Kit.

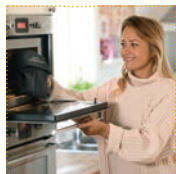

SPINEFITTER
not included

Item	Description
800424	SPINEFITTER by SISSEL Linum, anthrazit
800432	SPINEFITTER by SISSEL Linum Pro, anthrazit

19



approx. 84 x 12 x 2 cm



Linum: 100% cotton
Linum Pro: 100% polyester / PU coating



anthrazit



SPINEFITTER® by SISSEL® Multi Extension Kit



For greater exercise variety and targeted self-treatment

Expand the SPINEFITTER by SISSEL with two additional pairs of balls and the specially designed connector to achieve greater exercise variety. Introduce new training stimuli with the Multi Extension Kit and support specific areas of the body to optimise self-treatment in a more targeted way.

- Extends the regular SPINEFITTER by SISSEL by 12 cm (2 pairs of balls)
- Contains: 1 x SPINEFITTER by SISSEL Mini and 1 x Connector
- Expands the range of exercises
- Perfect for people taller than 180 cm
- Simple click system ensures correct alignment of the Extension Kit
- Enables precise self-treatment of certain parts of the body

SPINEFITTER by SISSEL Mini (without Connector)

- Extra small and light – perfect for traveling, in the office, or on the go
- Supports segmental spine mobilisation exercises
- Perfect for fascia release of individual areas
- Suitable for balance exercises and for strengthening of deep muscle structures
- Also available individually, without connector, incl. SPINEFITTER carrying strap
- Can be combined with the SPINEFITTER by SISSEL Trigger Tool



Item	Description
800409	SPINEFITTER by SISSEL Multi Extension Kit
800402	SPINEFITTER by SISSEL Mini
800413	SPINEFITTER Extension Kit Set of 5 (without Strap)

Extension Kit: approx. 21 x 12 x 6 cm
Mini: approx. 12 x 12 x 6 cm

polyurethane

black





SPINEFITTER® by SISSEL®

Accessories

SPINEFITTER® by SISSEL® Backpack

- The backpack for transporting one SPINEFITTER incl. mounted SPINEFITTER Linum/Linum Pro
- Backpack made of 100% cotton
- Colour: anthrazit



SPINEFITTER® by SISSEL® Drinking Bottle

An ideal training companion – this stainless steel drinking bottle keeps beverages at the desired temperature for an extended period of time.

- Double-walled, vacuum-insulated stainless steel bottle, food-safe
- Dishwasher safe
- Capacity: 500 ml
- Laser-engraved SPINEFITTER logo
- Material: stainless steel, silicone, PP
- Dimensions: approx. 23 x 6.7 cm



SPINEFITTER® by SISSEL® Coach Bag

- Matching carrying bag for 10 SPINEFITTER
- Enables easy transport of the SPINEFITTER for group training
- Dimensions: approx. 95 x 44 x 30 cm (when filled)
- Also available as a set incl. 10 SPINEFITTER (see page 16)
- Coach Bag made of 100% cotton



SPINEFITTER® by SISSEL® Towel

SPINEFITTER Towel reduces the pressure from SPINEFITTER on the musculature along the spine, allowing for more comfortable training.

- Material: 100% cotton
- Practical training companion for the gym – easily secured to a training bench thanks to the integrated loop
- Versatile in combination with the SPINEFITTER (e.g. as a head support or pressure-reducing base)

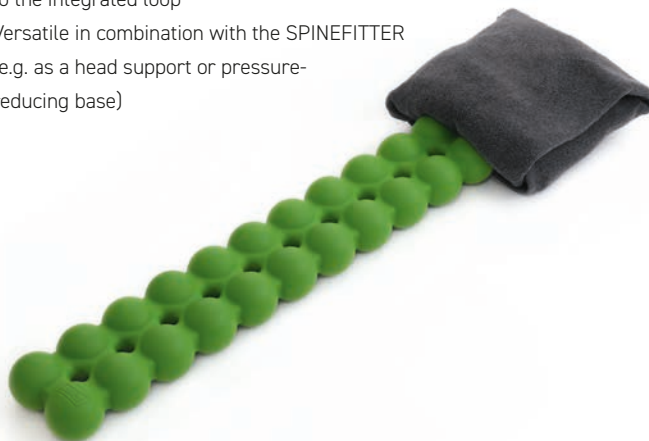

Item	Description
800427	SPINEFITTER by SISSEL Backpack, anthrazit – as long as stock lasts
800430	SPINEFITTER by SISSEL Coach Bag, anthrazit
800601	SPINEFITTER by SISSEL Drinking Bottle
800420	SPINEFITTER by SISSEL Towel
800530	SPINEFITTER by SISSEL Gym Mat Plus in Showbox
800528	SPINEFITTER by SISSEL Gym Mat Plus in bulk of 10 pcs.
800594	SPINEFITTER by SISSEL Display (SPINEFITTER not included)



Folded into a packet the Towel can be used as a comfortable headrest on the SPINEFITTER.



SPINEFITTER® by SISSEL® Gym Mat Plus

Slip-resistant, hard-wearing and antibacterial. Offers optimum support for your training.

- Dimensions: approx. 180 x 60 x 1 cm
- Material: NBR



SPINEFITTER® by SISSEL® Display

Metal frame with suspension and threading set for professional SPINEFITTER customer presentation.

- Dimensions (L x W x H): approx. 25 x 25 x 100 cm
- Weight: approx. 3.5 kg (without SPINEFITTER)
- Material display: steel, lacquered
- Material of accessory pack: acrylic glass, polyethylene
- Permissible load capacity of display: 5 kg
- SPINEFITTER not included

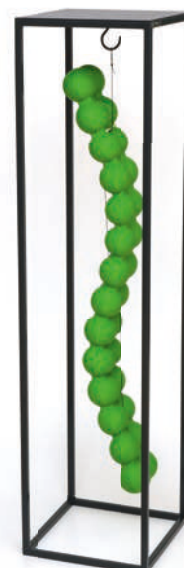

SPINEFITTER® by SISSEL®

Junior

NEW

YouTube



The training companion for children and adolescents

The SPINEFITTER Junior is aimed directly at the individual physiological needs of children (from the age of 4) and adolescents (up to approx. 60 kg). The innovative training tool for use in therapy and sport was developed together with physiotherapists and addresses typical challenges such as poor posture, motor development disorders and sensory integration problems. The SPINEFITTER Junior provides targeted support for improving core strength and can have a lasting positive effect on posture and body awareness. The child-friendly design and carefully selected, soft and tear-resistant material make the SPINEFITTER Junior a safe and durable training companion.

- Addresses the muscular, sensory and coordination challenges of children and young people
- The perfect companion to support and encourage children and young people in physiotherapy and sport
- Ideally suited for balance and coordination exercises or sensorimotor training
- Material testing in accordance with EN 71-3:2019+A1:2021 (Safety of toys – Part 3: Migration of certain elements)



approx. 72 x 9,5 x 4,5 cm



x:: EXTRALIGHT®



available in 2 colours



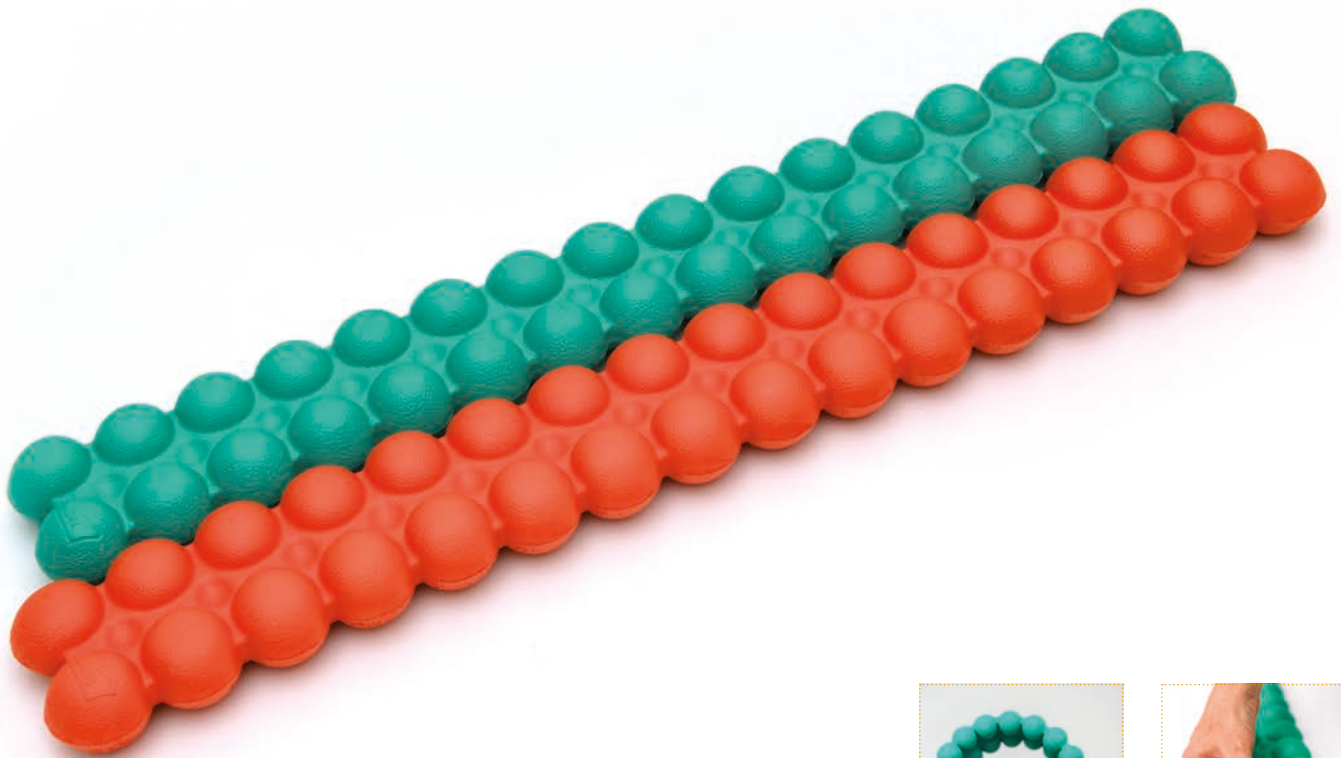

Item	Description
800743	SPINEFITTER by SISSEL Junior, lava
800747	SPINEFITTER by SISSEL Junior, ocean

Robust and child-appropriate material – for maximum stability and safety.



Stay Fit and in Shape

Discover products designed to improve mobility, strength, and endurance, or to effectively support rehabilitation.



SISSEL® SECUREMAX Ball

YouTube



Practical fitness tool and dynamic seating solution

- Ideal as a seating solution at school or at home
- Encourages correct sitting posture
- Reduces strain on the spine and strengthens the back muscles
- Suitable for therapy and exercise
- Includes exercise poster
- Surface features a pleasant texture and is highly abrasion-resistant
- Maximum user weight: 150 kg



SECUREMAX System:

Maximum safety – when punctured, the ball will not burst but will slowly lose air.

Item	Description
800716	SISEL SECUREMAX Ball, Ø approx. 45 cm, silver
800717	SISEL SECUREMAX Ball, Ø approx. 55 cm, silver
800209	SISEL SECUREMAX Ball, Ø approx. 65 cm, blue-purple
800213	SISEL SECUREMAX Ball, Ø approx. 65 cm, silver
800215	SISEL SECUREMAX Ball, Ø approx. 75 cm, blue-purple
800214	SISEL SECUREMAX Ball, Ø approx. 75 cm, silver



Ø approx. 45 cm, 55 cm, 65 cm, 75 cm



PVC



available in 2 colours



27

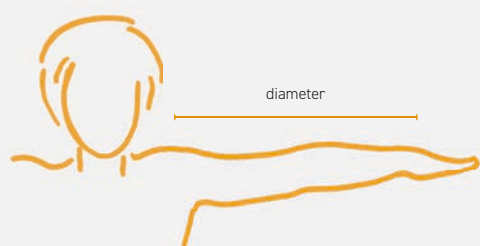

The ideal ball size

Measure the length of the arm from the shoulder to the hand. This measurement roughly corresponds to the required minimum diameter of the ball. Always choose the ball with the larger diameter.

Accessories for Gym Balls

SISSEL® Stabilizer

Holds the ball in place also when not used.
Made from high-quality polypropylene.

 YouTube

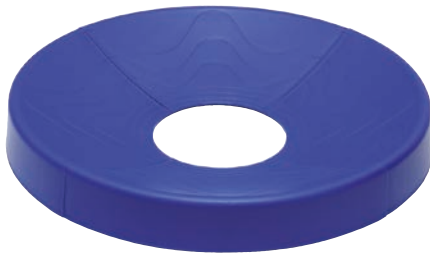

SISSEL® Stackers

Our 3-piece set of Stackers provides a space-saving storage of 3 balls at a time (for ball diameters of Ø approx. 65 cm and up).



SISSEL® Mini Hand Pump

The ultra strong Hand Pump – even works in case of strong counter pressure.



Item	Description
800216	SISSEL Stabilizer, Ø approx. 45 cm, quadripartite, blue
800218	Set of Stackers, acrylic, 3 pcs. – <i>as long as stock lasts</i>
800219	Hand Pump



SISSEL[®] Gym Ball Cover

YouTube



Turns your gym ball into a stylish piece of furniture

- Healthy sitting at home in a new look
- Pleasant fabric provides improved sitting comfort
- Adjustable handle for easy transport
- Hidden zipper – prevents damage to clothing and floors
- Washable at 40 °C

TIP

In combination with the SISSEL Stabilizer also protected against rolling off.



Item	Description
800205	SISSEL Gym Ball Cover, grey, 65 cm – as long as stock lasts



∅ approx. 65 cm



100% polyester



grey



SISSEL Fitbands – with reduced protein contents. Latex bands usually contain a high level of proteins. The SISSEL Fitband is different. Most of the proteins in the natural material latex have been removed by using a complex process. The result is a band proven to have fewer allergens.



SISSEL® Fitband Plus & SISSEL® Fitband Essential

YouTube





Flexible training for therapy and fitness

- Supports therapy, movement exercises and muscle increase for all ages
- Available in 4 levels of resistance for progressive exercising
- Less powder – nice to touch

SISSEL Fitband Plus includes a clip system (for approx. 7,5 cm x 2 m tape) for training everywhere where there is a door.



Item	Description
800435	Fitband Plus, yellow (light), approx. 7.5 cm x 2 m
800436	Fitband Plus, red (medium), approx. 7.5 cm x 2 m
800437	Fitband Plus, green (strong), approx. 7.5 cm x 2 m
800438	Fitband Plus, blue (x-strong), approx. 7.5 cm x 2 m
800439	Fitband Plus, yellow (light), approx. 15 cm x 5 m
800442	Fitband Plus, red (medium), approx. 15 cm x 5 m
800443	Fitband Plus, green (strong), approx. 15 cm x 5 m
800444	Fitband Plus, blue (x-strong), approx. 15 cm x 5 m
800445	Fitband Plus, yellow (light), approx. 15 cm x 25 m
800447	Fitband Plus, red (medium), approx. 15 cm x 25 m
800448	Fitband Plus, green (strong), approx. 15 cm x 25 m
800449	Fitband Plus, blue (x-strong), approx. 15 cm x 25 m
800455	Fitband Plus, yellow (light), approx. 15 cm x 46 m
800457	Fitband Plus, red (medium), approx. 15 cm x 46 m
800458	Fitband Plus, green (strong), approx. 15 cm x 46 m
800459	Fitband Plus, blue (x-strong), approx. 15 cm x 46 m
800460	Fitband Essential, yellow (light)
800462	Fitband Essential, red (medium)
800463	Fitband Essential, green (strong)
800464	Fitband Essential, blue (x-strong)

 Fitband Plus: approx. 7,5 cm x 2 m, 15 cm x 5/25/46 m
 Fitband Essential: approx. 15 cm x 2,5 m  latex

 available in 4 colours    

SISSEL® Fun & Active Band

Ideal for low-impact workouts

- Pleasant texture and extra tough
- Available in 3 different levels of resistance
- Pleasant to the touch material
- Latex free and odorless
- With practical sports box



YouTube



Item	Description
800466	SISSEL Fun & Active Band, orange, light
800467	SISSEL Fun & Active Band, yellow, medium
800468	SISSEL Fun & Active Band, green, strong

 approx. 15 x 200 cm

 TPE

 available in 3 colours   

SISSEL® Exercise Loop

For progressive muscle development in fitness and therapy

- For a wide range of applications: group and personal training, aqua gym and senior fitness
- Small, convenient and ready to use
- Ideal fitness aid for travelling
- Set of 2: 1 light for muscle build-up (yellow), 1 strong for fitness training and toning (green)

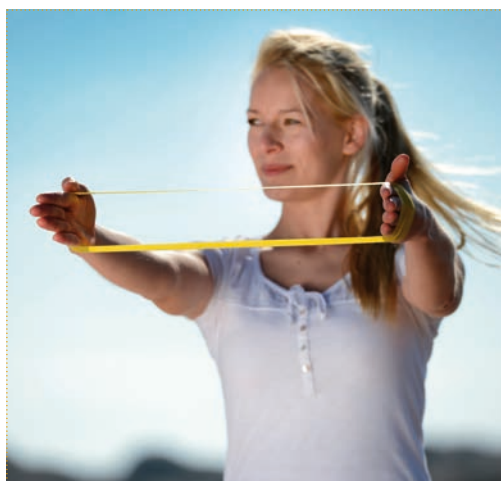

YouTube



Item	Description
800465	SISSEL Exercise Loop, set of 2, 1 yellow, 1 green

 approx. 5 cm x 33 cm

 latex

 set of 2 colours: green, yellow

SISSEL® OCTOCORE®

A groundbreaking, highly versatile training device

The guided, supported movement sequences in multiple dimensions restore the natural interplay between fascia, muscles, tendons, and ligaments. The SISSEL OCTOCORE can support the treatment of postural dysfunctions and evasive movements. The integrated loops allow for extensive variation of functional training. In addition, it can be used as a support for Pilates and Yoga and is ideal to take along on trips. The SISSEL OCTOCORE offers individual adjustment possibilities and enables a powerful and multidimensional training – from rehabilitation to competitive sports.

- X-shaped, elastic loop band for holistic and multi-dimensional training
- Washable at 30 °C



YouTube



Item	Description
800474	SISSEL OCTOCORE
800479	SISSEL OCTOCORE, Set of 10



approx. 190 x 190 cm



39% nylon, 35% polyester, 26% latex



anthracite-yellow



Discover our workshops on the SISSEL ACADEMY website

SISSEL® X-Tension Ring Set

YouTube



Elastic textile bands for versatile training

- 3 different tensile strengths allow effective training in every performance range
- For varied, targeted training of small muscle chains and individual muscles of the entire body
- Durable, dimensionally stable, skin-friendly
- Set consisting of 3 SISSEL X-Tension Ring with different tensile strengths: light (7 kg), medium (10 kg), strong (15 kg)
- Washable at 30 °C



Item	Description
800481	SISSEL X-Tension Ring Set

 length: approx. 33 cm

 39% nylon, 35% polyester, 26% latex

 Set consisting of 3 colours: yellow, red, green

SISSEL® X-Tension Band

YouTube



Versatile fabric band for fitness and strength training

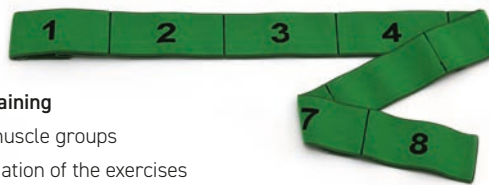

- For varied fitness and strength training of all muscle groups
- 8 numbered loops offer a simple and quick variation of the exercises
- 2 different tensile strengths allow effective training in every performance range
- Suitable for stretching and warming up before training sessions
- Durable, dimensionally stable, skin-friendly
- Washable at 30 °C



Item	Description
800470	SISSEL X-Tension Band, yellow, light – as long as stock lasts
800473	SISSEL X-Tension Band, green, strong – as long as stock lasts

 length: approx. 104 cm (8 loops à 13 cm)

 39% nylon, 35% polyester, 26% latex

 available in 2 colours  

33





34

SISSEL® Fit-Tube

Ideal for resistance and strength training

- For wellness, rehabilitation, muscle strengthening and aerobics
- Concise posture and stretching exercises for upper body and legs
- With hygienic, flexible handles for a better grip
- 3 different tensile strengths



YouTube



Item	Description
800451	SISSEL Fit-Tube, yellow (light) – as long as stock lasts
800452	SISSEL Fit-Tube, red (medium) – as long as stock lasts
800453	SISSEL Fit-Tube, blue (x-strong) – as long as stock lasts

 approx. 140 cm

 Tube: latex, handles: PVC, Strap: polypropylene yarn

 available in 3 colours   

SISSEL® Door Anchor

Flexible door attachment for resistance bands and tubes

- Easy adjustment by clamping in the door
- Variable placement side, top or bottom of the door for targeted training of the core, shoulder and upper arm muscles

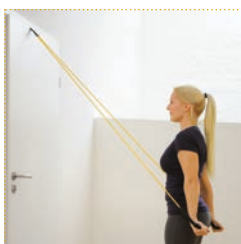

Item	Description
800450	SISSEL Door Anchor



approx. 6.5 cm x 3.2 cm



polyester/polypropylene



black

SISSEL® Sport Swing Plus

The multifunctional fitness bar for dynamic core exercises

- Designed to specifically address trunk musculature, for cardio and strength training, motion exercises, training of deep musculature and improving posture and coordination
- Specially developed for professional use in sports and fitness
- Ergonomically shaped handle for convenient usage and safe grip
- High-quality, anti-slip handle and end pieces made from TPR and silicone
- Extremely rugged bar with perfectly tuned vibration action
- Particularly compact due to shortened dimensions

YouTube



35



Item	Description
800326	SISSEL Sport Swing Plus
800327	SISSEL Sport Swing Plus, in bulk of 10 pcs.



approx. 115 cm



Staff: fiberglass
Handle & Weights: TPR, silicone



red/dark blue

SISSEL® Gym Mat

YouTube



The perfect training mat – hygienic and easy to clean

- Skin-friendly, warm, hygienic, easy to clean
- Handy and easy to roll up
- Anti-slip, rugged – optimal shock absorbing qualities
- From high-quality foam for better pressure resistance
- Modern wave structure with rounded edges



Hanging Rings for 60 cm SISSEL Gym Mats

- Space saving option to store more SISSEL gym mats
- Inside diameter: approx. 3 cm
- 2 hanging rings per mat

Distances:

- Distance inner ring to inner ring: approx. 45 cm
- Distance edge to ring (both sides): approx. 5.5 cm



Contact your SISSEL product distributor for more information on quantities, packing etc.

TIP:
Hanging rings can be retrofitted for space-saving storage.

Item	Description
800507	SISSEL Gym Mat, blue, approx. 180 x 60 x 1.5 cm
800504	SISSEL Gym Mat, blue, approx. 180 x 60 x 1.5 cm, in bulk of 10 pcs.
800510	SISSEL Gym Mat, grey, approx. 180 x 60 x 1.5 cm
800509	SISSEL Gym Mat, grey, approx. 180 x 60 x 1.5 cm, in bulk of 10 pcs.

 approx. 180 x 60 x 1 cm
approx. 180 x 60 x 1.5 cm

 NBR foam

 available in 2 colours  

SISSEL® Gym Mat Professional

YouTube



Optimal balance between shock absorption and pressure distribution for floor exercises

- Solid surface for better hygiene, skin-friendly, warm
- Anti-slip
- Made from sturdy foam for optimal pressure resistance and durability in professional use
- Extremely tear-resistant, rugged
- Rolls out flatly
- Modern wave structure with rounded edges

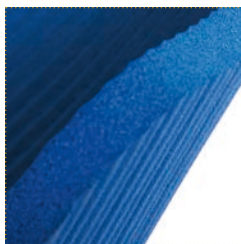

Item	Description
800522	SISSEL Gym Mat Professional, blue Only available in bulk without packaging.

 approx. 180 x 100 x 1.5 cm

 NBR foam

 blue



37

SISSEL® Gym Mat Plus

Unique material properties and the bevelled edge design – no 'roll-up' effect

- Closed cell surface structure allows for easy cleaning
- Excellent cushioning properties due to the unique foam structure
- Extremely durable
- Very good anti-slip properties for a safe workout
- Straight, minimalist design blends seamlessly into any environment
- Bevelled edges reduce the risk of stumbling
- Optimal pressure resistance



Item	Description
800527	SISSEL Gym Mat Plus, anthracite, in Showbox
800523	SISSEL Gym Mat Plus, anthracite, in bulk of 10 pcs.

 approx. 180 x 60 x 1 cm

 NBR foam

 anthracite

SISSEL® EPIFLOW Kinesiology Tape



The taping innovation for skin and tissue activation

The easily shapeable activation flap of the EPIFLOW Tape allows for manual mobilisation of skin areas and deeperlying tissue. This expands its range of applications in scar treatment and local lymphatic drainage. The EPIFLOW Tape is also used in physiotherapy, rehabilitation, and (high-performance) sport to improve muscle function and support pain reduction.

- Innovative activation flap
- Gentle action on the deeper skin layers
- Promotes flexibility and blood circulation in the tissue
- Supportive aid to promote lymph flow in cases of primary or secondary lymphoedema
- May help to loosen and improve blood circulation in areas of scar tissue

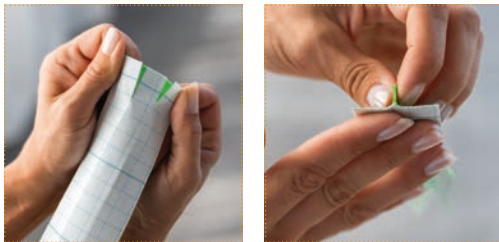

Item	Description
800730	SISSEL EPIFLOW Kinesiology Tape beige
800731	SISSEL EPIFLOW Kinesiology Tape blue
800732	SISSEL EPIFLOW Kinesiology Tape pink
800733	SISSEL EPIFLOW Kinesiology Tape black
800734	SISSEL EPIFLOW Kinesiology Tape lime green
800735	SISSEL EPIFLOW Kinesiology Tape brown

 approx. 5 cm x 5 m

 96% cotton, 4% elasthane, acrylic adhesive

 available in 6 colours 



SISSEL[®] Kinesiology Tape

YouTube



The kinesiology tape in four attractive colours

- For use in sports
- Support of joint and muscle mobility
- Breathable, water resistant
- Comfortable and skin-friendly
- Each roll individually packed



Item	Description
800371	SISSEL Kinesiology Tape, approx. 5 cm x 5 m, natural-coloured
800372	SISSEL Kinesiology Tape, approx. 5 cm x 5 m, blue
800373	SISSEL Kinesiology Tape, approx. 5 cm x 5 m, pink
800374	SISSEL Kinesiology Tape, approx. 5 cm x 5 m, black
800375	SISSEL Kinesiology Tape, approx. 5 cm x 32 m, natural-coloured
800376	SISSEL Kinesiology Tape, approx. 5 cm x 32 m, blue
800377	SISSEL Kinesiology Tape, approx. 5 cm x 32 m, pink
800378	SISSEL Kinesiology Tape, approx. 5 cm x 32 m, black



approx. 5 cm x 5 m
approx. 5 cm x 32 m



96% cotton, 4% elasthane,
acrylic adhesive



available in 4 colours



SISSEL[®] Knee Roller

NEW

39

For individualised and effective rehabilitation of the knee joint – in therapy and at home.

- Improves of flexion and extension
- Targeted strengthening of the muscles surrounding the knee
- Enables quadriceps training from a deep flexion position
- Precise and selective activation of all four parts of the quadriceps



Variable curvature with different widths, precisely adaptable to each patient's individual anatomy.



Item	Description
800806	SISSEL Knee Roller



approx. 26.5 x 28 cm



50% PE, 50% EVA



blue marbled

Balance & Stability

Improve your balance, coordination, and strength with our training tools. Strengthen your core with ease as part of your everyday routine.



SISSEL® Fit-Dome Sport

YouTube



The fitness device for balance, strength and cardio training

- For a versatile and effective full-body workout
- Platform facing up or down permits balance training in many variations
- Functional and sports-oriented exercise tool
- Challenging in individually varying degrees
- With pump and exercise poster
- Training tubes included
- Burst-proof up to 130 kg dynamic weight



Item	Description
800262	SISSEL Fit-Dome Sport, black - <i>as long as stock lasts</i>



∅ approx. 60 cm, 22 cm high



Ball: 100% PVC
Frame: 100% PP



black



SISSEL® Spiky Dome

YouTube



Find your balance and have a fun workout

- For better coordination and balance
- To increase physical perception and mobility
- Suitable for all ages
- Blissful foot massage, relaxing due to nub pattern
- One solid piece
- Pressure individually adjustable
- Max. body weight: 80 kg
- Set of 2 with one red and one blue

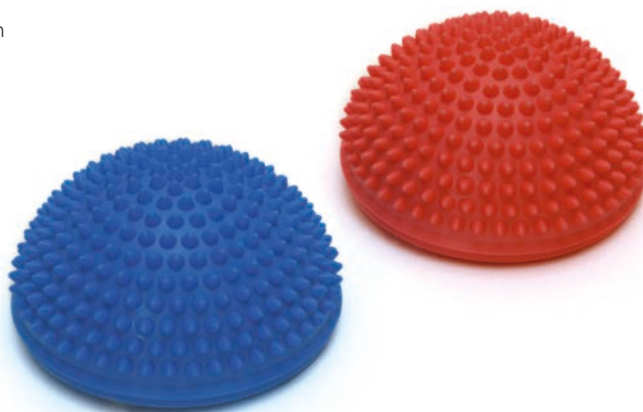
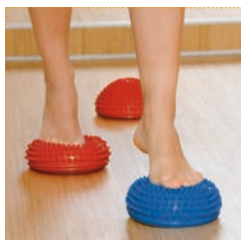

Item	Description
800282	SISSEL Spiky Dome, set of 2: 1 red, 1 blue

Ø approx. 16 cm

PVC

set of 2 with one red and one blue

SISSEL® Balancefit

YouTube



Improves balance, physical coordination, strength and circulation

- Specially shaped knobbles in two different thicknesses on the standing surface increase the body's perceptive ability
- For foot-massage, e.g. for varicose vein relief exercises
- Also suitable to exercise pelvic floor
- Can also be used as an active, dynamic sitting aid
- With needle-valve for individual pressure regulation
- Max. body weight: 130 kg



Item	Description
800311	SISSEL Balancefit, red
800313	SISSEL Balancefit, blue

approx. Ø 32 cm

PVC

available in 2 colours

SISSEL® Balancefit Pad (Large)

Ideal balance training

- for coordination, reaction training, and stability exercises
- Neuromuscular exercises for maintaining balance proficiency
- For indoor, outdoor and water use
- With anti-slip coating
- Free of PVC
- Max. body weight: 120 kg

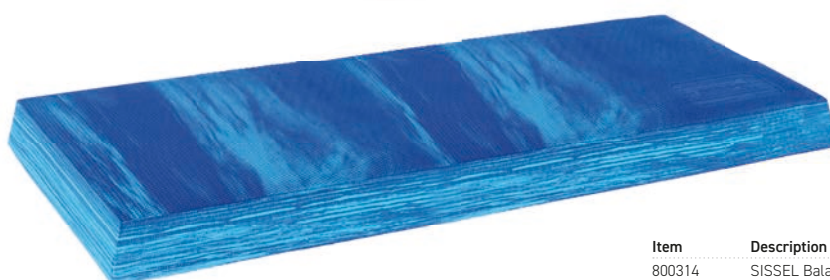

Model
Large

YouTube



SISSEL Balancefit Pad



SISSEL Balancefit Pad Large



Item	Description
800314	SISSEL Balancefit Pad, blue marbled
800317	SISSEL Balancefit Pad, black marbled
800316	SISSEL Balancefit Pad Large, blue marbled



Balancefit Pad: approx. 50 x 41 x 6 cm
Balancefit Pad large: approx. 95 x 41 x 6 cm



TPE/EVA



Balancefit Pad: blue marbled, black marbled
Balancefit Pad Large: blue marbled





SISSEL® Balance Board Plus

Space-saving training aid for outdoor use,
in the gym or at home

- For balance and proprioceptive training
- Improves coordination and motor skills
- Strengthens the deep muscles
- Improves concentration
- With integrated handles for more effective training
- Max. body weight: 90 kg



YouTube



Item	Description
800319	SISSEL Balance Board Plus

 Ø approx. 38 cm, height: approx. 8,5 cm

 polyethylene

 red

SISSEL® Balance Board Dynamic

Improves balance and coordination

- The Balance Board Dynamic is a versatile training device that can be used for balance training and many other exercise variations
- For progressive exercising without changing equipment
- Max. body weight: 150 kg

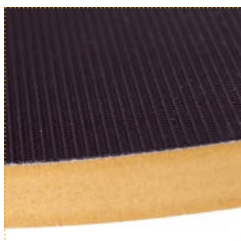

Item	Description
800330	SISSEL Balance Board Dynamic – <i>as long as stock lasts</i>



∅ approx. 40 cm, height: approx. 8 cm



wood, with non-slip PVC surface



black / wood

45

SISSEL® Step-Fit

YouTube



The natural pebble beach for your home

- Optimization of whole body coordination
- Sensitivity training for combining with other substrates
- Foot reflexology massage
- Stimulation of metabolism
- Balance training
- Strengthening of the muscles

Also suitable for parcours application with other proprioceptive devices.

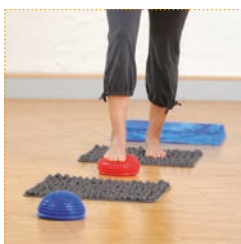

Item	Description
800322	SISSEL Step-Fit, approx. 48,5 x 49 cm, grey



approx. 48.5 x 49 cm



TPR



grey

Fascia Release

Our fascia products help release muscle tension and support post-exercise recovery.



SISSEL® Myofascia Roller

The fascia roller to enhance muscle activity and regeneration

- For targeted release and relaxation of muscles and fascial soft tissue
- Improvement of muscle function, regeneration and flexibility
- Prevention of muscle soreness
- Areas of application: massage of neck, shoulder, upper arm and back musculature, hip and calf muscles, front/inner/back thighs
- Ideal addition to sports, physiotherapy, osteopathy
- Intense, deep penetrating massage
- Shape-retaining, rugged, easy to use
- Anatomically optimized size – for extra comfort, adjusted to hip/shoulder width
- With ergonomic recess for safe usage and proper exercising
- Recyclable, odorless

YouTube



Item	Description
800343	SISSEL Myofascia Roller, blue – as long as stock lasts
800345	SISSEL Myofascia Roller, blue/soft white – as long as stock lasts
800346	SISSEL Myofascia Roller, lime green – as long as stock lasts
800349	SISSEL Myofascia Roller, magenta/lime – as long as stock lasts



Ø approx. 15 cm, length approx. 40 cm



EPP



available in 4 colours



SISSEL[®] Myofascia Ball

YouTube



The fascia ball for deep tissue self-massage

- For releasing muscle tension and fascial tension in hard-to-reach areas of the body
- For self-massage and targeted release of tense muscles
- For intensive pressure massage of neck, feet and back
- Improvement of muscle function, regeneration and flexibility
- Use on the floor, table or on the wall
- Recyclable, odorless



Item	Description
800351	SISSEL Myofascia Ball, approx. 8 cm, black – as long as stock lasts
800354	SISSEL Myofascia Ball, approx. 12 cm, black – as long as stock lasts

 available in 2 sizes:
∅ approx. 8 cm, ∅ approx. 12 cm

 EPP

 black

47

SISSEL[®] Myofascia Double Ball

YouTube



The massage tool for fascial release of back, neck and leg muscles

- For self-massage and targeted release of tense muscles
- Simultaneously targets tensions, constrictions of the muscles aligned on both sides of spinal column
- For intensive pressure massage of neck, calf and leg muscles
- Use on the floor or on the wall
- Recyclable, odorless

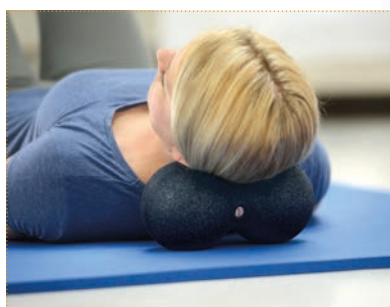

Item	Description
800360	SISSEL Myofascia Double Ball, 8 x 16 cm, black – as long as stock lasts
800363	SISSEL Myofascia Double Ball, 12 x 24 cm, black – as long as stock lasts

 available in 2 sizes:
approx. 8 x 16 cm, approx. 12 x 24 cm

 EPP

 black



48

SISSEL® Mobilizor Set

YouTube



Versatile companion for massage, stretching, and mobilisation

- Supports massage treatments, stretching, and mobilisation exercises
- Ideal for Pilates and yoga stretching exercises
- Nubbed version is ideal for targeted massage
- Smooth version is ideal for fascia release techniques
- Set of 2 SISSEL Mobilizor (smooth version/textured version)



Item	Description
800289	SISSEL Mobilizor Set – as long as stock lasts

 smooth – approx. 24 x 12 x 8 cm
 nubbed – approx. 24 x 12 x 9 cm

 PP

 1 x lime green, 1 x light blue

SISSEL® Vitalyzor



YouTube



The full body soft tissue release system to vitalize your muscles

- For muscle release and activation
- Fibrous connective tissue, knotted by injuries or degeneration, can be precisely targeted and released
- Preparation for stretching and relaxation exercises
- Ideal device to target tenseness throughout the entire body, especially the back
- Hygienic, skin-friendly, portable

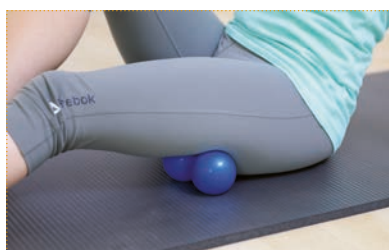

Item	Description
800272	SISSEL Vitalyzor – as long as stock lasts



approx. 15 x 7.5 cm



silicone



blue

49

SISSEL® Massage Roller

YouTube



Rolling away tensions

- Use to treat muscle tensions and for massage of connective tissue
- Ideal for massage and relaxation
- For prevention of muscle tension
- Enhances circulation
- Suitable for the massage of back and leg muscles



Item	Description
800564	SISSEL Massage Roller, approx. 47 cm, blue



∅ approx. 15 cm, length: approx. 47 cm long



PE



blue

Yoga

Find greater balance and calm in your everyday life – with high-quality yoga products that provide stable support for your practice and help you move with greater awareness in every posture.



SISSEL® Yoga Relax Cushion Fresh Green

YouTube



Comfortable seating through optimal height

- Provides excellent support – also suitable as a base for many yoga postures
- Offers stable support for proper meditation posture
- The spelt husk filling is temperature-regulating, moisture-wicking, breathable, and pressure-relieving
- Inner cover with zip for easy refilling
- Separate high-quality cover, washable at 40 °C



Item	Description
800038	SISSEL Yoga Relax Cushion, fresh green



Ø approx. 40 cm, height: approx. 11.5 cm



Cover: 100% cotton
Filling: 100% pure spelt filling



fresh green



SISSEL® Yoga Block

The accessory for easier practice

- Suitable for Yoga beginners as well as pros
- Extremely light, sturdy blocks, dimensionally stable





YouTube



Item	Description
800333	SISSEL Yoga Block, burgundy
800334	SISSEL Yoga Block, cork

 burgundy: approx. 22.5 x 7.5 x 15 cm
solid cork: approx. 23 x 7.5 x 12 cm

 2 models available:
foam (burgundy)/solid cork

 2 models/colours available:
burgundy, solid cork

SISSEL® Yoga Belt

Getting away from everyday life with concentration, selected exercises and relaxation

- Suitable for Yoga beginners as well as pros
- Fortified cotton strap



Item	Description
800331	SISSEL Yoga Belt, approx. 1.8 m - as long as stock lasts
800332	SISSEL Yoga Belt, approx. 3 m

 approx. 3.75 x 180 cm
approx. 3.75 x 300 cm

 100% cotton

 natural-coloured

SISSEL® Yoga Socks

The anti-slip socks for Yoga, Pilates, dance and barefoot exercises

- With especially warm, padded bottom for maximum comfort
- Rubberized, anti-slip bottom for a safe stand and correct exercising
- With thermal-regulating effect, deodorising
- Washable at 30 °C



Item	Description
800369	SISSEL Yoga Socks, S/M (36-40) - as long as stock lasts
800370	SISSEL Yoga Socks, L/XL (41-45) - as long as stock lasts

 S/M (36-40)
L/XL (41-45)

 65% cotton, 5% elastane, 25% rubber, 5% nylon

 black

SISSEL® Yoga Mat

The classic yoga mat

- Wipeable, rolls up easily



Item	Description
800520	SISSEL Yoga Mat, fuchsia – <i>as long as stock lasts</i>

 approx. 180 x 60 x 0.4 cm

 PVC

 fuchsia

SISSEL® Terra Yoga Mat

The premium yoga mat

- Optimal shock absorbing properties, elastic and comfortable
- Superior grip surface, non-slip
- Heat and cold resilient
- PVC- and latex-free, non-allergenic
- Double sided use
- Cleaning: with a damp cloth or hand shower

 YouTube



Item	Description
800521	SISSEL Terra Yoga Mat – <i>as long as stock lasts</i>

 approx. 183 x 61 x 0.4 cm

 TPE

 red-anthracite

SISSEL® Pilates & Yoga Mat

YouTube



A high-quality anti-slip mat for Pilates and yoga exercises

- Wipe clean surface, rolls up easily
- With an attractive fabric border



Item	Description
800576	SISSEL Pilates & Yoga Mat

 approx. 180 x 60 x 0.6 cm

 PVC/polyester

 bordeaux



Pilates Matwork

Enhance your Pilates training with premium equipment that improves the precision of your movements and visibly supports your progress.



Pilates – Body & Mind Training

The secret of the method lies in its holistic approach, with positive effects on both body and mind: Pilates tones the body and improves flexibility, strength, endurance, and inner balance.

Pilates matwork is the most widely recognised form of Pilates training. Joseph Pilates (1883–1967), the founder of the renowned Pilates method, developed numerous gentle yet highly effective exercises that can be performed on a mat.

Depending on the desired level of difficulty, small equipment such as balls or rollers can be used to vary the exercises. Pilates matwork can be practised easily at home. In addition, many fitness studios and physiotherapy practices have integrated this training method and offer Pilates matwork as personal training or in group classes.

'In 10 sessions you'll feel the difference, in 20 sessions you'll see a difference, and in 30 sessions you'll have a whole new body.'

Joseph Pilates

SISSEL® Pilates Circle

Great variety of exercises for core and leg strength

- Resistance training ring
- Enclosed fibreglass ring with padding on both sides
- Diversifies and intensifies many pilates exercises
- For systematic core and leg workout
- Soft and comfortable due to anti-slip coating
- Latex-free





YouTube



Item	Description
800559	SISSEL Pilates Circle, incl. exercise poster
800563	SISSEL Pilates Circle Compact, incl. exercise poster

 SISSEL Pilates Circle: Ø approx. 38 cm
SISSEL Pilates Circle Compact: Ø approx. 30 cm

 fibreglass, ABS plastic handles,
EVA foam padding, NBR rubber

 SISSEL Pilates Circle: black
SISSEL Pilates Circle Compact: lime green

55

SISSEL® Pilates Core Trainer

All-round tool for an effective core workout

- Use to strengthen back, arm and leg musculature
- For a targeted shaping of individual problem zones
- Suitable for fitness, aerobics and therapy
- With four loops for simultaneous training of arms and legs
- With high-quality hygienic handles for a safe grip and easy handling
- Medium strength for effective resistance training



YouTube



Item	Description
800587	SISSEL Pilates Core Trainer, lime green – as long as stock lasts

 approx. 60 x 60 x 2.8 cm

 latex

 lime green

SISSEL® Pilates Roller

The SISSEL Pilates Roller range offers the ideal complement to Pilates mat training, particularly for balance and stabilisation exercises as well as for fascia release.



Item	Description
800547	SISSEL Pilates Roller, approx. 90 cm, white
800548	SISSEL Pilates Roller Pro, approx. 90 cm, solid blue
800555	SISSEL Pilates Roller Pro, approx. 90 cm, grey
800550	SISSEL Pilates Roller Pro, approx. 100 cm, solid blue
800557	SISSEL Pilates Roller Pro, approx. 100 cm, grey
800551	SISSEL Pilates Roller Pro Soft, approx 90 cm, blue marbled
800552	SISSEL Intense Roller, approx. 100 cm, black

 Ø approx. 15 cm
Length: see product description

 see product description

 see product description 



SISSEL Pilates Roller

- Entry-level model, ideal for home use
- Material: PE
- Length approx. 90 cm
- Colour: white



YouTube



SISSEL Pilates Roller Pro

- More durable, recommended for application in the therapy practice and studio
- Material: PE/EVA
- Length approx. 90 cm or 100 cm
- Colour: blue, grey



YouTube

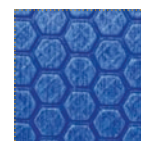

SISSEL Pilates Roller Pro Soft

- Softer, therefore more comfortable and easy to keep in balance, ideal for beginners
- Material: EVA
- Length approx. 90 cm
- Colour: blue marbled



YouTube



SISSEL Intense Roller

- Dimensionally stable and robust, thus a more unstable and challenging support surface, ideal for advanced users
- Material: EPP
- Length approx. 100 cm
- Colour: black



YouTube

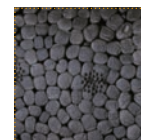



SISSEL® Pilates Roller Head Align Dynamic

Reliable neck-support for Pilates exercises

- Practical tool for Pilates mat and roller exercises
- Prevents over-extension of cervical spine
- For optimal body alignment
- Keeps head in an anatomically correct position
- Rounded shape for dynamic positioning
- Can be used with the curved side facing up or down

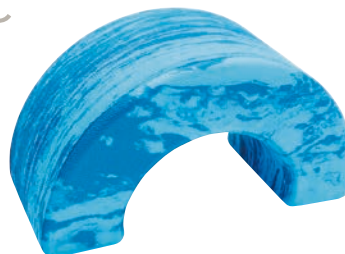

YouTube



Item	Description
800586	SISSEL Pilates Roller Head Align Dynamic, blue marbled

 Fits any standard SISSEL Pilates Roller (Ø approx. 15 cm)

 PE

 blue marbled

SISSEL® Pilates Roller Center

Space-saving accessory designed to store up to 5 rollers

- Accommodates all SISSEL Pilates Rollers

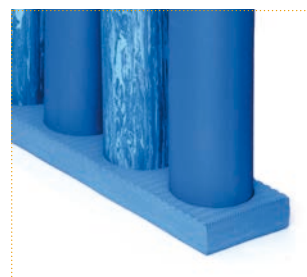
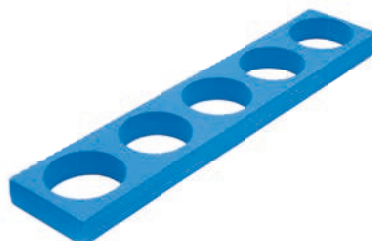

Item	Description
800585	SISSEL Pilates Roller Center, blue

 approx. 95 x 19.5 x 6 cm

 PE

 blue

SISSEL® Pilates Toning Ball

YouTube



A perfect addition to your Pilates mat programme

- Exercises arms, shoulders, and upper body
- Toning balls can be easily integrated into many more Pilates exercises
- Available in 2 weights: approx. 450 and 900 g
- Set of 2



Item	Description
800572	SISSEL Pilates Toning Ball, approx. 450 g, set of 2, blue
800574	SISSEL Pilates Toning Ball, approx. 900 g, set of 2, blue

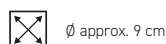

∅ approx. 9 cm



PVC
Filling: sand



blue

SISSEL® Pilates Soft Ball

YouTube



Ideal for strengthening the muscles

- Specifically designed for spine and abdominal muscle training
- Max. body weight: 155 kg



Item	Description
800566	SISSEL Pilates Soft Ball, ∅ approx. 22 cm, blue
800567	SISSEL Pilates Soft Ball, ∅ approx. 26 cm, blue
800569	SISSEL Pilates Soft Ball, ∅ approx. 22 cm, metallic
800571	SISSEL Pilates Soft Ball, ∅ approx. 26 cm, metallic



∅ approx. 22 cm
∅ approx. 26 cm



PVC



available in 2 colours



SISSEL® Pilates Band

For stable movements and a more powerful Pilates workout

- Made of cotton canvas with 6 integrated pockets to hold hands or feet according to the exercise selected
- Simple support for increased core stability and perfect posture while exercising
- Offers resistance thus increasing the intensity of the exercise



YouTube



Item	Description
800578	SISSEL Pilates Band, natural-coloured
800579	SISSEL Pilates Band, blue
800580	SISSEL Pilates Band, red

 approx. 20 x 125 cm

 100% cotton

 available in 3 colours   

SISSEL® Pilates Workout Gloves

Safe grip for pilates, mat exercises, suspension and weight training

- Hygienic, anti-bacterial and sweat-absorbent
- Rubberized anti-slip palm for a safe grip
- Comfortable, rugged and breathable
- Exposed fingers for better tactile perception
- Especially recommendable for sensitive hands
- Machine washable at 30 °C



Item Number	Attributes
800589	SISSEL Workout Gloves, black - as long as stock lasts

 one size

 80% viscose, 18% polyester and 2% elastane

 black

SISSEL® Pilates One Toe Socks

Functional one toe socks in attractive ballerina look

- For a safe stand while Pilates, yoga and relaxation exercises
- Moisture regulating, rugged, ideal in combination with flip-flops
- Comfortable fit
- With Coolmax fiber and rubberized anti-slip bottom
- Machine washable at 30 °C



YouTube

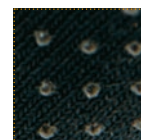

Item	Description
800581	S/M (36-39) – as long as stock lasts
800582	L/XL (40-42) – as long as stock lasts

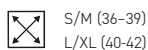

S/M (36-39)
L/XL (40-42)



58% polyester, 36% cotton,
4% polyamide, 2% elastane



black



61

SISSEL® Pilates Socks

Toe socks with non-slip sole

- Improve tactile perception
- Hygienic, antibacterial and odour-neutral
- With thermal regulating effect: warm and comfortable in cold weather; breathable and cool in hot weather
- Optimal moisture balance – absorb sweat and keep feet comfortably dry
- Washable at 30 °C



Item	Description
800583	viscose, S/M (35-39), fuchsia – as long as stock lasts
800584	viscose, S/M (35-39), sky blue – as long as stock lasts



S/M (35-39)



70% viscose, 25% polyester, 5% elastane



available in 2 colours



Hand Therapy

Training the muscles of the hands and fingers is essential in therapy. Grasping, holding, and rotating objects are automatic movements, and their loss can significantly affect everyday life. Particularly with increasing age, after injuries, or in the case of certain conditions, dexterity can decline considerably.



SISSEL® Press Ball & Press Egg

 YouTube

Work your hands and forearms

- Permits a specific training of musculature and improves the mobility of hand and forearm
- Works all muscles in your hand and fingers
- SISSEL Press Ball – especially suitable for finger therapy
- SISSEL Press Egg – ideal for hand rehabilitation
- Available in 4 different resistances

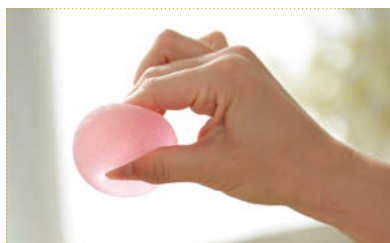

Item	Description
800291	SISSEL Press Ball, pink (soft)
800292	SISSEL Press Ball, blue (medium)
800293	SISSEL Press Ball, green (strong)
800294	SISSEL Press Ball, orange (x-strong)
800295	SISSEL Press Egg, pink (soft)
800296	SISSEL Press Egg, blue (medium)
800297	SISSEL Press Egg, green (strong)
800298	SISSEL Press Egg, orange (x-strong)

 Press Ball: Ø approx. 4,5 cm
Press Egg: approx. 6,5 x 4,5 x 4,5 cm

 TPE

 available in 4 colours 

63

SISSEL® Finger Exerciser

Finger and hand mobilization

- Flexible hand and finger trainer to increase strength of hand and finger coordination
- Regular exercise improves flexibility, mobility and strength
- PVC/Latex free, washable
- Available in 4 resistances



Latex free

Item	Description
800306	SISSEL Finger Exerciser, 4 pcs., x-soft/soft
800307	SISSEL Finger Exerciser, 4 pcs., medium/firm

 Ø approx. 6,5 cm

 TPE

 blue/pink, orange/green

SISSEL® Twin Grip

YouTube



Hand trainer – highly elastic, flexible and odor-free

- Maintains and increases flexibility
- Promotes muscle build-up in rehabilitation
- Relaxing
- Set of 2 with 2 resistances (pink-soft/green-medium)
- Recyclable



Item	Description
800335	SISSEL Twin Grip, set of 2

 approx. 5 cm (∅ of small ball), approx. 5.8 cm (∅ of large ball); height: approx. 11.5 cm

 TPE

 pink/green



SISSEL® Putty

YouTube



Putty for finger and hand exercises

- Use to strengthen and mobilise the fingers and hands
- Improves flexibility
- Trains fine motor skills
- Use after surgery, injuries of the hand or rheumatic ailments
- Softer material, especially suitable for therapy and rehabilitation
- Available in five different resistances, permit a continuous increase in training



Item	Description
800299	SISSEL Putty, ivory (x-soft), approx. 85 g
800300	SISSEL Putty, yellow (soft), approx. 85 g
800301	SISSEL Putty, red (medium), approx. 85 g
800302	SISSEL Putty, green (strong), approx. 85 g
800303	SISSEL Putty, blue (x-strong), approx. 85 g



approx. 85 g,
Box approx. 6 cm



Silicone elastomer



available in 5 colours





Healthy Sitting

Active, dynamic sitting relieves strain on the upper body and strengthens the back muscles. Find the right support for your daily sitting routine – whether in the office, in the car, or at home. For comfortable, upright, and healthy sitting wherever you are.



SISSEL® SITFIT Plus

YouTube



Active sitting with a 2-in-1 function

- Perfect combination of a wedge seat and an air-filled seat cushion
- Optimal balance of active sitting and seating comfort thanks to the anatomical shape
- The special shape allows the cushion to be rotated as needed. Sitting on the front thigh support is recommended for beginners
- Active and dynamic sitting relieves strain on the upper body and strengthens the back muscles without targeted training
- Helps to promote an upright posture
- Also suitable for training the back and pelvic floor muscles
- Includes pump for individual pressure adjustment
- Max. body weight: 138 kg

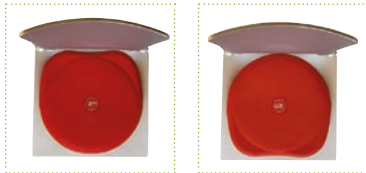

Round side in the front:

- active and dynamic sitting
- suitable for short sitting intervals and exercises

Thigh rest in the front:

- stabilized sitting due to thigh rest
- suitable for long sitting intervals

Latex free



Options:

- Velours cover (75% cotton/25% polyester), available in black



- Textured cotton cover available in sand colour (100% cotton)



New cover



Item	Description
800230	SISSEL SITFIT Plus, blue
800231	SISSEL SITFIT Plus, red
800232	SISSEL SITFIT Plus, black
800235	Cover, Ø approx. 37 cm, velours, black
800236	Cover, Ø approx. 37 cm, organic cotton, sand
800239	Pump for SITFIT Plus

SISSEL® SITFIT

Keeps your back fit

- For training the back and pelvic floor muscles
- For strengthening the muscles of the feet and legs
- Relieves strain on the upper body and strengthens the back muscles
- Can also be used as an active and dynamic seating option
- Variable pressure adjustment via valve for individual settings
- Max. body weight: 138 kg

Options:

- Velours cover (75% cotton/25% polyester), available in 3 colours



- Textured cotton cover available in sand colour (100% cotton)



New cover



Latex free



YouTube



It's never too early for healthy sitting

The SISSEL SITFIT Ø 33 cm is also ideally suited for children and teenagers.

Extended periods of sitting at the computer, doing homework, or studying can be turned into effective back training at the same time.

Item	Description
800241	SISSEL SITFIT, Ø approx. 33 cm, black
800244	SISSEL SITFIT, Ø approx. 33 cm, blue
800250	SISSEL SITFIT, Ø approx. 36 cm, black
800252	SISSEL SITFIT, Ø approx. 36 cm, blue
800247	Cover, Ø approx. 33 cm, velours, black
800245	Cover, Ø approx. 33 cm, velours, bordeaux – as long as stock lasts
800248	Cover, Ø approx. 33 cm, organic cotton, sand
800253	Cover, Ø approx. 36 cm, velours, blue – as long as stock lasts
800256	Cover, Ø approx. 36 cm, velours, black
800257	Cover, Ø approx. 36 cm, organic cotton, sand

Ø approx. 33 cm
Ø approx. 36 cm

PVC

available in 2 colours



SISSEL® SITFIT and SISSEL® SITFIT Plus – More than just a seat cushion

Use the exercise poster for a balanced full-body workout.

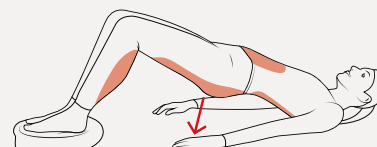
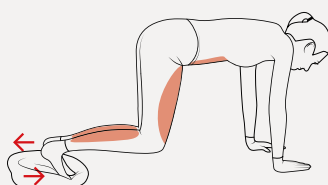
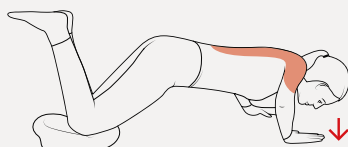



SISSEL® Sit Special 2 in 1

For comfortable, soft, and upright sitting – helps relieve pressure on the sacrum and coccyx

- Relieves spinal column and intervertebral discs
- Ideal aid after injuries and operations
- No sliding, even during long sitting periods
- Unique bridge and two anatomical depressions improve the quality of sitting and provide an even more convenient sitting experience
- 5 years warranty on dimensional stability
- Washable by hand
- Velours cover washable at 40 °C

With a removable recess in the sacrum area for pressure relief



YouTube



Item	Description
800090	SISSEL Sit Special 2 in 1, incl. cover, blue
800095	SISSEL Sit Special 2 in 1, incl. cover, grey
800091	Extra cover, blue structured
800096	Extra cover, grey structured

 approx. 43 x 40 x 9 cm

 Cover: 100% polyester
Filling: polyurethane foam, viscoelastic foam

 available in 2 colours  

SISSEL® Sit Standard & Colour



Promote a perfectly upright posture

- Relieve spine and intervertebral discs and this way enhance an ergonomically and anatomically correct sitting posture
- Stable core, cut from one piece
- Cover washable at 30 °C
- Note: best use for short periods, for longer sitting we recommend the use of SISSEL Sit Special 2 in 1 with anti-slide effect

Sitting Wedge Colour

With rugged cover and anti-slip bottom layer, highly effective on slippery surfaces

SISSEL Sit Standard with cover blue, black, burgundy



SISSEL Sit Colour with rubberized bottom



Sitting wedges are made of 100% rebonded foam

Item	Description
800084	SISSEL Sit Colour, blue/graffiti - <i>as long as stock lasts</i>
800085	Extra cover, SISSEL Sit Colour, blue/graffiti - <i>as long as stock lasts</i>
800100	SISSEL Sit Standard, with cover, blue
800102	SISSEL Sit Standard, with cover, black
800105	SISSEL Sit Standard, with cover, burgundy - <i>as long as stock lasts</i>
800088	Extra cover, SISSEL Sit Standard, black
800089	Extra cover, SISSEL Sit Standard, blue
800616	Extra cover, SISSEL Sit Standard, burgundy - <i>as long as stock lasts</i>



approx. 35 x 35 x 6.5 cm



Cover: 100% cotton
Filling: 100% rebonded PU-foam



available in 4 colours



SISSEL® Sit Air

YouTube



The comfortable wedge cushion for active, upright sitting

- Promotes continuous, gentle activation of the back and core muscles
- Seat comfort and sitting dynamics can be adjusted via an integrated valve
- Anatomically optimised design to help prevent heat build-up
- For added comfort during long and uncomfortable journeys by aeroplane or train
- Mesh cover allows for improved air circulation

Perfect for travel - easy to roll up and store thanks to the integrated valve



Underside with anti-slip coating

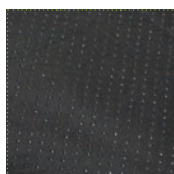

Item	Description
800107	SISSEL Sit Air, black - <i>as long as stock lasts</i>



approx. 35.5 x 35 x 5.5 cm



Cover: 100% polyester
Filling: PU foam



black

SISSEL® DorsaBack

YouTube



Comfortable sitting everywhere

- Prevention and rehabilitation of back problems
- Comfortable sitting everywhere – on all chairs, even too soft or deep ones, on all couches
- Supports the entire back
- Corrects a poor posture
- Variable sitting angle (from upright to lying)
- Encourages healthy, upright sitting
- Easy to transport, weighs only 2.3 kg
- Covered in a durable fabric

Optional accessory: SISSEL DorsaBack-Pad for SISSEL DorsaBack

- Height-adjustable lumbar support
- Colours and material identical to the SISSEL DorsaBack



Item	Description
800117	SISSEL DorsaBack, black
800118	SISSEL DorsaBack, grey
800119	SISSEL DorsaBack, blue - <i>as long as stock lasts</i>
800120	SISSEL DorsaBack-Pad, black
800121	SISSEL DorsaBack-Pad, grey



DorsaBack Backrest (L x W x H): approx. 49 x 32.5 x 3.5 cm
 DorsaBack Seat (L x W x H): approx. 39.5 x 43.5 x 3 cm
 DorsaBack-Pad: approx. 30 x 11.5 x 6.5 cm



Cover: 50% polyester / 50% polyamide
 Inlay: ergonomically moulded wood



available in 3 colours

SISSEL® DorsaBack-Car

Use the comfort of the SISSEL DorsaBack while driving in your car

- Anatomically shaped wooden core
- Provides large-area support for the back along its entire length
- Easily attaches to any car seat using retaining straps
- Matching lumbar support, SISSEL DorsaBack Pad, also available

SISSEL DorsaBack-Pad
(optional accessory)

SISSEL DorsaBack-Car



Item	Description
800113	SISSEL DorsaBack-Car, black
800115	SISSEL DorsaBack-Car, grey
800120	SISSEL DorsaBack-Pad, black
800121	SISSEL DorsaBack-Pad, grey



DorsaBack-Car (L x W x H): approx. 49 x 36 x 3.5 cm
DorsaBack-Pad: approx. 30 x 11.5 x 6.5 cm



Cover: 50% polyester / 50% polyamide
Inlay: ergonomically moulded wood



available in 2 colours



Please note: This product is not suitable for seats with integrated side airbags in the backrest.



SISSEL® Sit Ring

Pleasant and pressure-free sitting anywhere

- Everyday sitting support
- For local pressure relief
- Use when suffering from obstructed sitting especially after surgeries of the perineum, anal lesions, hemorrhoids or during / after pregnancy
- Material maintains its shape, hypo-allergic and flame-resistant
- Eudermic terry cover, washable at 60 °C
- Cushion core washable by hand
- Available in 2 variations: round or oval

Option:

- PU hygiene cover (liquid-tight)



74

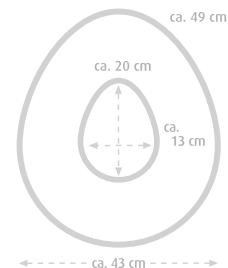
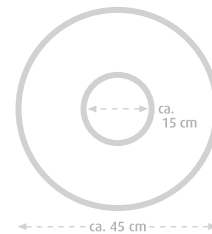

Item	Description
800135	SISSEL Sit Ring, incl. terry cover, round, white
800139	SISSEL Sit Ring, incl. terry cover, oval, white
800140	Extra cover, round/oval, terry, white
800136	Extra cover, round/oval, PU, blue

Ø approx. 45 cm
approx. 43 x 49 cm

Cover: 80% cotton/20% polyester
Filling: polyurethane foam

white

SISSEL® Back

Special treatment for a „car-damaged“ lumbar spinal column

- Upright, improved sitting while driving
- Supports lumbar spine during long car rides
- Gently guides the spine into a relaxed and healthy position
- Easy and fast mounting on every car seat thanks to two sturdy belts
- Cover washable at 40 °C



Note: do not use if seat rests are equipped with integrated side impact air bags



Item	Description
800132	SISSEL Back, grey
800133	Extra cover, grey structured

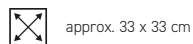

approx. 33 x 33 cm



Cover: 100% polyester



grey

75

SISSEL® Tour

The height-adjustable lumbar support

- Secures to the car seat with an elastic band
- Ideal for vehicles without integrated lumbar support
- Adjustable in height – can be adjusted to individual needs
- Cover washable at 40 °C



Item	Description
800123	SISSEL Tour, black



approx. 31.5 x 25.5 x 5.5 cm deep



Cover: 100% cotton
Filling: PU foam



black



Well-Being

Heat therapy products help relieve rheumatic conditions, muscle tension, and back pain. Cold therapy supports the reduction of swelling, while our portable therapy devices can be used flexibly in different settings. Relax and recover with our well-being products.



Hot-Cold Therapy

Enjoy soothing warmth for the shoulders, back, abdomen, and joints – ideal for relaxation and well-being. Heat is often recommended for rheumatic conditions, muscle tightness, acute back pain, and menstrual discomfort. Cold therapy, on the other hand, helps reduce swelling and has a calming and relaxing effect.



SISSEL® Hot-Cold Pearl Masks & Packs

YouTube



The hot-cold packs with pearl gel filling – soothing and relaxing

- Innovative, flexible pearl gel filling
- Areas of application: swellings, inflammations, bruises/sprains, sports injuries, headaches/migraine, muscle aches, beauty treatments, relaxation
- Suitable for preparation for or regeneration after sports
- Anatomically adjusted models for targeted application
- Retains flexibility – even when frozen
- Use: store in refrigerator/freezer for cold applications, simple heating in microwave
- Reusable, hygienic
- Available in 4 variations



SISSEL Hot-Cold Pearl Eye Mask:

Especially for itching/watery/red/puffy eyes, headaches/migraine (size: approx. 23 x 10 cm open, with hook-and-loop fastener)

SISSEL Hot-Cold Pearl Facial Mask:

Especially for facial swellings/inflammations, headaches/migraine, beauty treatments (size: approx. 18.5 x 21 cm open, with opening for eyes/nose/mouth and hook-and-loop fastener)

SISSEL Hot-Cold Pearl Relief Pack:

Especially for swellings, inflammations, bruises/sprains, sore muscles, insect bites, preparation/regeneration after sports (size: approx. 27 x 14 cm)



innovative, flexible pearl gel filling

SISSEL Hot-Cold Pearl Sports Pack:

Especially for swellings, inflammations, bruises/sprains, sports injuries, sore muscles, muscle aches, insect bites, preparation/regeneration after sports (size: approx. 17 x 11 cm)

Item	Description
800176	SISSEL Hot-Cold Pearl Eye Mask
800172	SISSEL Hot-Cold Pearl Facial Mask
800174	SISSEL Hot-Cold Pearl Relief Pack
800178	SISSEL Hot-Cold Pearl Sports Pack

see product description

Cover: PVC
Filling: gel beads

blue



79

SISSEL® Pack

SISSEL Pack compresses are ideal for home and therapy applications

- Quick microwave or hot water heating
- Keep in refrigerator for cool pack applications
- Affordable and universal application
- Retains flexibility up to -18 °C
- Option: SISSEL Pack incl. cover (100% polyester) with elastic strap



Item	Description
800156	SISSEL Pack, without cover, without packaging
800155	SISSEL Pack, incl. cover, with packaging

approx. 12 x 24.5 x 1.5 cm

Cover: PE/PA
Filling: gel

blue



SISSEL® Hot-Cold Soft Pack

Especially suited for back applications

- Warm or cold application
- Can be heated in water or microwave
- Textile-like surface



Item	Description
800162	SISSEL Hot-Cold-Soft-Pack, blue/burgundy

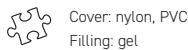
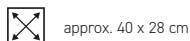

SISSEL® Cold Therapy Compression

Cold and compression combined

- 2 piece compress with removable, individually coolable cold pad
- Areas of application: inflammations, swellings, pains, sports injuries, rheumatic conditions
- Reduction of pain and inflammation
- Cold and compression provide prevention of swellings
- With pump for pressure regulation
- Slow Flow Gel provides long-lasting and safe temperature preservation
- Convenient hook-and-loop fastener ensures correct fit on every joint
- Hygienic and easy to disinfect
- Available in 3 variations: wrist, knee/elbow, ankle
- Option: replacement pads available

YouTube



Item	Description
800199	SISSEL Cold Therapy Compression wrist
800201	SISSEL Cold Therapy Compression ankle
800203	SISSEL Cold Therapy Compression knee/elbow
800200	Replacement Pad wrist
800202	Replacement Pad ankle
800204	Replacement Pad knee/elbow

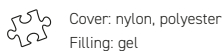
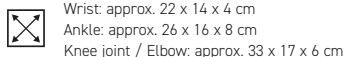

SISSEL® Therm

YouTube



Self-activating hot pack

- Fluid and transparent before usage, after activating, it smoothly contours to your body
- Heats up to approx. 54 °C within seconds
- Reusable many times, boil for 15 minutes to return to original state



Item	Description
800169	SISSEL Therm, tri-sectional

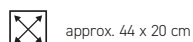

approx. 44 x 20 cm



Cover: PVC
Filling: gel



orange



SISSEL® Soft Touch Pro

YouTube



Tri-sectional heat pack: Permits specific treatment of neck, kidney, back and shoulder regions

- Fast heating in microwave
- Pleasant heat regulation
- Convenient and simple handling
- Perfect tri-sectional fit
- Pleasant to the touch surface
- Easy to clean

Treats sports injuries, bruises, etc. with cold therapy

- Cool in refrigerator or freezer compartment
- Flexible even when cold



Item	Description
800158	SISSEL Soft Touch Pro



approx. 40.5 x 23 x 1.5 cm



Cover: polyester coated PVC
Filling: gel



blue



SISSEL® Comfy Belt

YouTube



Comfortable warmth – at home and on the go

- For warm hands and a warm stomach or selective warming of the lower back
- Handmuff with soft inner lining – Pleasant to wear, provides comfortable warmth
- Precise positioning with a perfect fit due to the Velcro closure
- Due to the narrow closure, the belt can be used as a back warmer even while sitting
- Convenient inner pocket for holding a heat pad
- Suitable for use with SISSEL heat pads (e.g. SISSEL Cherry, sold separately)

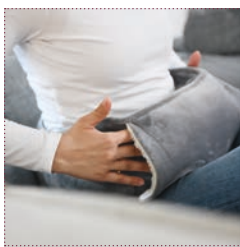

For waist sizes from approx. 70 cm to 125 cm seamlessly adjustable (approx. 60-115 cm with heat pad inserted)



Item	Description
800198	SISSEL Comfy Belt – as long as stock lasts

 approx. 145 x 20 x 2 cm
inner pocket: approx. 18 x 26 cm

 polyester

 grey

SISSEL® Hydrotemp

YouTube



For deep-penetrating moist heat application

- Perfect for back, neck and shoulder pain, muscle aches, arthritis and tensions
- Draws moisture from the air and releases it as clean, deep-penetrating moist heat when microwaved, additional moistening is not necessary
- Perfect for therapy and home use or wherever deeply penetrating heat is desired
- Delivers therapeutic warmth for up to 30 minutes
- Easy to use, simply microwave and apply

Underneath a pleasant, skinfriendly cover special microbeads store pure moisture and release it when microwaved.

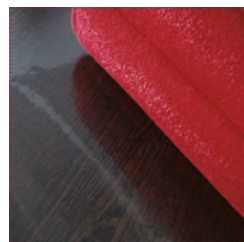
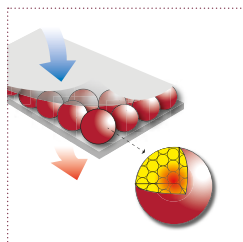



lower back



neck / shoulder

Item	Description
800193	SISSEL Hydrotemp, neck / shoulder
800196	SISSEL Hydrotemp, lower back, approx. 32.5 x 19 cm

 Lower back: approx. 32.5 x 19 cm with two belts
Neck/shoulder: approx. 49 x 25.5 cm with two strings

 Cover: polyester, polyurethane
Filling: mineral microspheres

 dark red



SISSEL® Vinotherm

YouTube



Natural heating pad – tri-sectional. For specific treatment of neck, shoulder, back and kidney region

- 100% grape seed filling – no further filling material added
- Pleasant scent when heated
- Tri-sectional shape for convenient usage and perfect fit
- Easy and fast heating in microwave or oven



Advantages of grape seed filling

Grape seeds are naturally fine and fit snugly and lightly to the body. They contain grape seed oil which stores heat for a long time and releases it as a dry warmth which penetrates deep into the body. Use: To relax tense muscles, warm up muscles before massage or for cold-related discomfort.

Item	Description
800190	SISSEL Vinotherm, tri-sectional

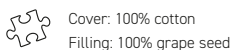
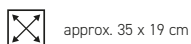

SISSEL® Aroma Neck Roll

YouTube



Aroma neck roll with natural filling – warming, stimulating, relaxing

- Soothing warmth application with invigorating herbal scent
- Relaxing and stimulating
- Natural filling of linseed and spelt, enhanced with aromatic herbs
- Easy warming in microwave
- Also for cold application
- Double sided use



Item	Description
800081	SISSEL Aroma Neck Roll

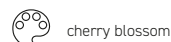
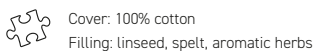
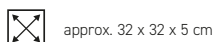



SISSEL® Linum



Linseed compresses – a proven natural remedy

- Useful, multiple applications
- Smooth and soft, it contours to your body, providing a pleasant and effective application
- Pleasant relief where warmth is required – helps treat muscle tensions, indisposition due to cold and stomach pains
- Heat up in microwave or oven
- Available in 2 variations and 2 colours



SISSEL Linum Anatomic



SISSEL Linum Classic

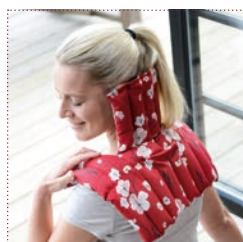

Item	Description
800179	SISSEL Linum Anatomic, approx. 38 cm x 36 cm, cherry blossom
800180	SISSEL Linum Anatomic, approx. 38 cm x 36 cm, blue
800183	SISSEL Linum Classic, approx. 45 cm x 30 cm, blue
800187	SISSEL Linum Classic, approx. 45 cm x 30 cm, cherry blossom
800181	SISSEL Linum Anatomic, extra cover, approx. 38 cm x 36 cm, blue

 Linum Classic: approx. 45 x 30 cm (rectangular shape)
 Linum Anatomic: approx. 38 x 36 cm (tri-sectional shape)

 Cover: 100% cotton
 Filling: linseed

 available in 2 colours      

SISSEL® Linum Cervico

YouTube



Helps relieve muscular tension in the neck and shoulder area

- Contours perfectly to shoulders, neck, and cervical spine
- Pleasant, therapeutically beneficial warmth for the throat and upper chest
- Pleasant cooling of the neck in case of fever, heat treatment in case of a headache
- Hook-and-loop fastener for easy adjustments
- Genuine natural product
- Sustainable, reusable
- Easy heating in the microwave or oven, cooling by storing it in the refrigerator



Item	Description
800188	SISSEL Linum Cervico



approx. 43 x 26 x 0.8 cm



Cover: 100% cotton
Filling: 100% linseed



dark blue



SISSEL® Cherry

Natural cherry heat pack for healthy warmth

- Proven device for therapy and home use
- Use as heat pack for treating back pain, muscular tensions, indigestion etc.
- Cherry stones provide gentle massage
- Simple heating in microwave or oven
- Also for cold application
- Available in 4 colours and also as a red heart

approx. 23 x 26 cm



approx. 20 x 40 cm

approx. 23 x 26 cm

heart-shaped



Advantages of cherry stone filling

Cherry stones warm up very quickly and release heat slowly and steadily. They fit snugly to the body and provide a sense of well-being.

Item	Description
800152	SISSEL Cherry, approx. 23 x 26 cm, blue
800167	SISSEL Cherry, approx. 23 x 26 cm, red
800153	SISSEL Cherry, approx. 23 x 26 cm, cherry blossom design
800161	SISSEL Cherry, approx. 23 x 26 cm, cherry design
800160	SISSEL Cherry, heart-shaped
800163	SISSEL Cherry, approx. 20 x 40 cm, blue
800166	SISSEL Cherry, approx. 20 x 40 cm, red



approx. 23 x 26 cm (medium)
approx. 20 x 40 cm (large)



Cover: 100% cotton
Filling: cherry stones



available in 4 colours



SISSEL® Cherry Heat Belt



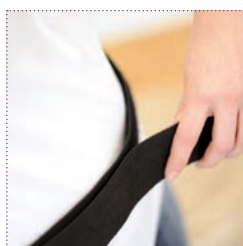

Blissful warmth for tense back muscles

- Sustainable nature product
- Slightly moist heat eases back tensions and pains
- Can also be used to treat stomach cramps and colic
- Provides warmth together with massage effect
- Relaxing, enhances circulation
- Ideally contours to the body for an effective treatment
- Convenient heating in microwave
- With practical hook-and-loop fastener



Item	Description
800150	SISSEL Cherry Heat Belt, cherry blossom

 approx. 50 x 17 cm (without belt), one size

 Cover: 100% cotton
Filling: cherry stones

 cherry blossom



87

SISSEL® Balu





Likeable cherry stone pouch for young and old

- Heat up in microwave or oven



Item	Description
800189	SISSEL Balu, orange

 approx. 16.5 x 24 cm

 Cover: 100% cotton
Filling: cherry stones

 orange



Massage

Effective massage to relieve tension and stress. Suitable for use at home or on the go.



SISSEL® Fit-Roller

YouTube



The ideal massage program

- A combination of traditional Chinese natural healing practices with up-to-date knowledge
- Use to treat muscle and tension complaints
- Enhances blood circulation, boosts metabolism
- Combination of pointy and round knobs works on different tissue zones
- Traditionally used to aid lymph circulation
- European product, beech, oiled
- Massage parts: PVC

SISSEL Fit-Roller, Super King Size Roll

For massage of the foot reflex zone, approx. 31 x 24.5 x 10 cm

SISSEL Fit-Roller, Head and Migraine-Roll

Approx. 17 cm

SISSEL Fit-Roller, Rope-Roll

Approx. 8 x 141 cm (incl. ropes)

SISSEL Fit-Roller, Uno-Roll

Approx. 16.5 x 8.3 x 4 cm

SISSEL Fit-Roller, Ergo-Roll

Approx. 13 x 9 x 10 cm

SISSEL Fit-Roller, T-Roll

For the long musculature along the spinal column, approx. 16 x 9 cm

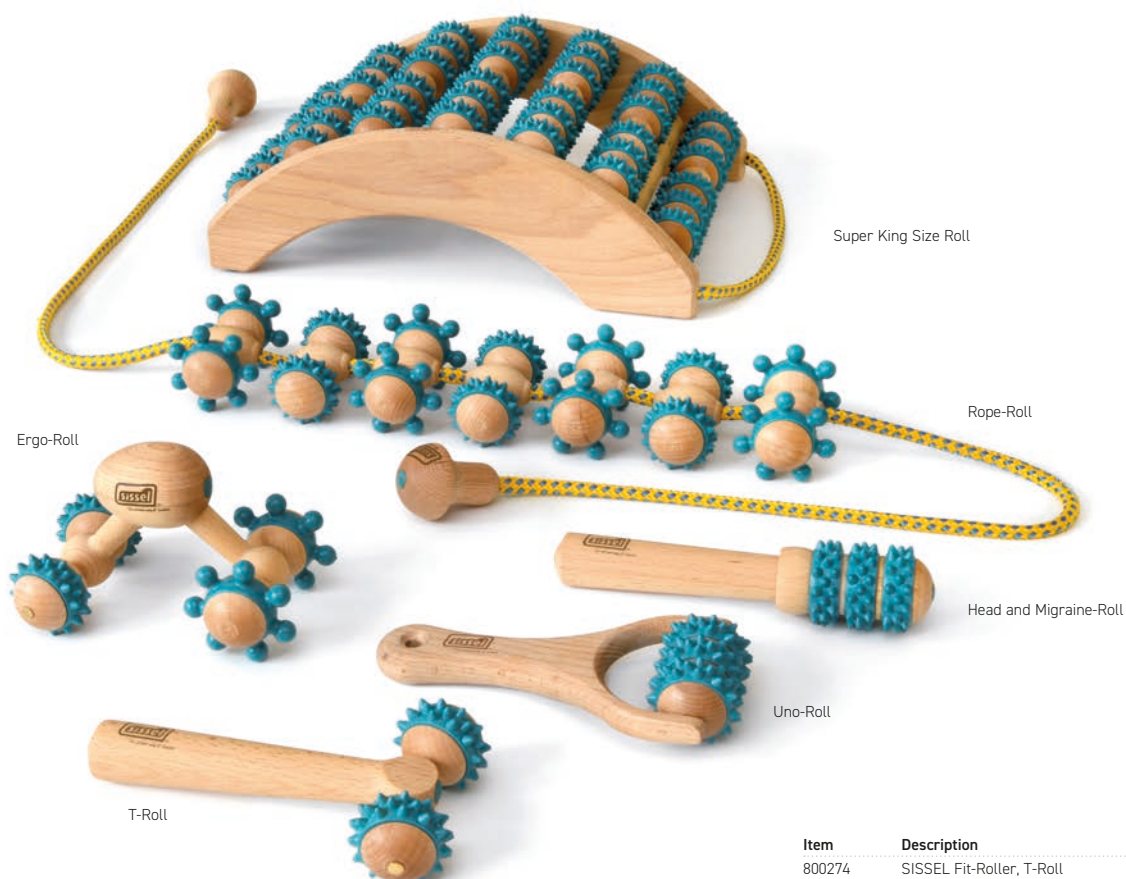

Super King Size Roll

Rope-Roll

Ergo-Roll

Head and Migraine-Roll

Uno-Roll

T-Roll

Item	Description
800274	SISSEL Fit-Roller, T-Roll
800276	SISSEL Fit-Roller, Ergo-Roll
800277	SISSEL Fit-Roller, Rope-Roll
800278	SISSEL Fit-Roller, Super King Size Roll
800280	SISSEL Fit-Roller, Head and Migraine-Roll
800281	SISSEL Fit-Roller, Uno-Roll

see product description

wood parts: beech | massage heads: PVC
rope: polyester

wood/petrol



SISSEL® Spiky Twin Roller

YouTube



Ideal for relieving muscle tension and related discomfort

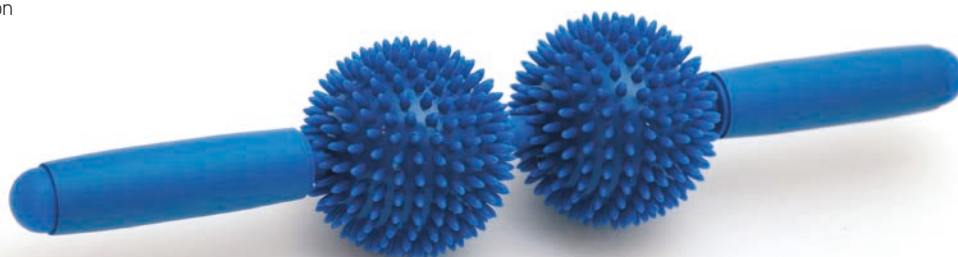

- Perfectly suited for the massage of the long muscles alongside the spinal column
- Designed to support circulation and stimulation of metabolism
- May improve blood and lymphatic circulation
- Also suitable for reflexology
- May support cellulite reduction
- Made for longterm use



Item	Description
800321	SISSEL Spiky Twin Roller, blue
800324	SISSEL Spiky Twin Roller, lilac

 approx. 43 x 0.9 x 0.9 cm

 PVC

 available in 2 colours  



91

SISSEL[®] Spiky-Ball

 YouTube

Simple tool to support blood circulation and relieve muscle tension

- Especially suited for massage of the foot reflex zone
- One-piece design, with valve
- Economic set of two



Item	Description
800266	SISSEL Spiky Ball, yellow (∅ approx. 8 cm), set of two
800268	SISSEL Spiky Ball, red (∅ approx. 9 cm), set of two
800270	SISSEL Spiky Ball, blue (∅ approx. 10 cm), set of two



∅ approx. 8 cm, ∅ approx. 9 cm, ∅ approx. 10 cm



PVC



available in 3 colours



SISSEL® Neck Relax

YouTube



Relaxation and massage in one

- Relaxes the muscles in the neck area thanks to its ergonomic shape
- Effective massage of fascia tissue through the nodular surface
- Additional use for mobilisation of the thoracic spine area



Item	Description
800336	SISSEL Neck Relax

 approx. 16.5 x 14.5 x 6.5 cm

 PVC

 blue



SISSEL[®] Acupressur Mat

Revitalising and promotes blood circulation

- Size and intensity can be individually adjusted
- Easy to use
- Washable and suitable for disinfection

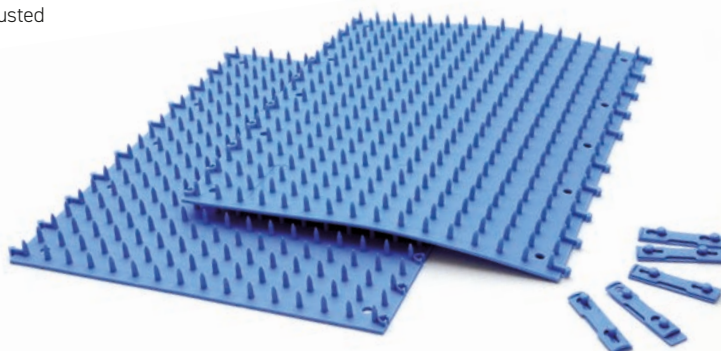
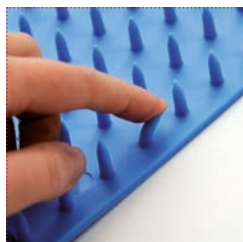

YouTube



Item	Description
800284	SISSEL Acupressur Mat, two-part, light blue

 approx. 40 x 65 cm, two-part,
height of acupressure tips: approx. 1.5 cm

 TPE

 light blue



SISSEL® Funmassager

YouTube



Experience effective trigger point treatment

- Easy and functional applications
- Small and convenient massager for home-use and to go
- Offers a deep or superficial massage of neck and back
- Enhances circulation and loosens muscles



Item	Description
800263	SISSEL Funmassager, blue
800264	SISSEL Funmassager, green – as long as stock lasts



approx. 11.2 x 9.3 x 7.1 cm



Polystyrol



available in 2 colours





SISSEL® Mobilyzor Set

YouTube



Versatile companion for massage, stretching, and mobilisation

- Supports massage treatments, stretching, and mobilisation exercises
- Ideal for Pilates and yoga stretching exercises
- Nubbed version is ideal for targeted massage
- Smooth version is ideal for fascia release techniques
- Set of 2 SISSEL Mobilyzor (smooth version/textured version)



Item	Description
800289	SISSEL Mobilyzor Set – as long as stock lasts



smooth – approx. 24 x 12 x 8 cm
nubbed – approx. 24 x 12 x 9 cm



PP



1 x lime green
1 x light blue

SISSEL® Massage Roller

Roll away tension with ease

- Ideal for massage and relaxation
- Helps to loosen the muscles and support connective tissue massage
- Helps prevent muscle tension
- Improves blood circulation
- Suitable for massage of the back and leg muscles



Ideal for fascia release.
Find more fascia release
products on pages 46-49

Find more information on page 49.

Inversion for Back Problems

Full or partial inversion naturally stretches the back, allowing the spine and weight-bearing joints to relax and recover. The degree of stretch is determined by the body's own weight and is therefore automatically adjusted.



SISSEL® Hang Up

The inversion table for home and professional use

- Increasing stress on musculature, joints and the spinal column caused by physical activities, like sports, excessive workouts, bending, lifting, long sitting or standing lead to compression and rotation pressure and are often the reason for complaints
- The reversed strain during exercises with the inversion table automatically creates a relief
- Eases tensions, contributing to a sustainable pain relief
- Enhances blood circulation
- Can also be used for athletic workouts, such as sit-ups
- Fast set up, space-saving storage
- The compact inversion table
- Suitable for body heights of approx. 1.40 m up to 1.98 m
- Maximum height approx. 2.05 m to 2.09 m (with maximum body height adjustment)
- Max. body weight: approx. 110 kg



Item	Description
800544	SISSEL Hang Up, black - as long as stock lasts



Maximum height approx. 2.05 m to 2.09 m



black, silver





Healthy Sleeping

The unique shape of all SISSEL orthopaedic neck pillows ensures optimal shoulder positioning, even when lying on your side, helping to relieve pressure on the vertebrae and intervertebral discs. Form, quality, and design – proven for over 40 years.

SISSEL[®] Orthopaedic Neck Pillows



Form, quality, and design – proven for over 40 years!

The shape of all SISSEL orthopaedic neck pillows provides defined support in the lower cervical spine area. As a result, the entire shoulder and neck region is supported. Thanks to its unique contour, the pillow fits smoothly between the shoulder and the cervical spine, filling the space and guiding the spine gently into its anatomically correct position.

Due to a slight stretching effect on the neck and spine, the adjustment may initially feel unfamiliar. The body needs some time (2 to 14 nights) to adapt again to natural, healthy sleep and to lying on an anatomically shaped original SISSEL neck pillow.

In the supine position, the support gently gives way due to the available space, allowing the shoulders to relax and sink down. The chest opens, and the neck is lengthened.

Our neck pillows are made from polyurethane foam with excellent support capacity:

- SISSEL Orthopaedic Pillow Classic
- SISSEL Orthopaedic Pillow Classic Plus

Our neck pillows are made from viscoelastic foam, a soft and highly adaptive material:

- SISSEL Orthopaedic Pillow Soft
- SISSEL Orthopaedic Pillow Soft Plus
- SISSEL Orthopaedic Pillow Soft Deluxe
- SISSEL Orthopaedic Compact Pillow
- SISSEL Orthopaedic Pillow Soft Bambini

All pillows are hand-washable. For further details, please refer to the individual product descriptions.

YouTube



The unique contour of all SISSEL orthopaedic neck pillows ensures that the shoulder is positioned correctly, allowing the spine and intervertebral discs to be optimally supported.

A conventional pillow does not provide sufficient support for the neck and cervical vertebrae.

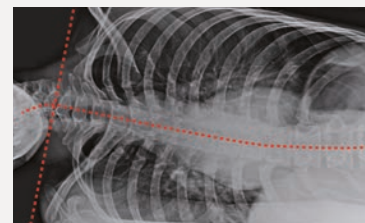
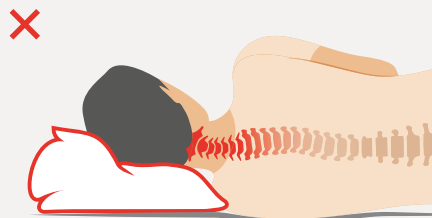

The SISSEL Orthopaedic Pillow provides perfect support for the neck, no matter how you lie.

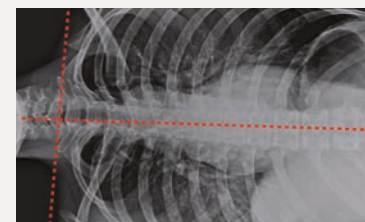
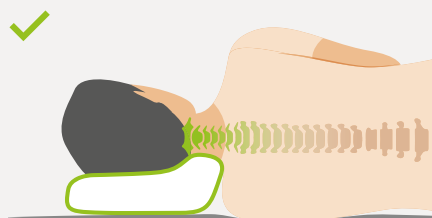



101

Scientific background: neck problems and referred neck pain

Excerpt from a study¹ by Hugh Smythe, MD, University of Toronto

Pain originating in the neck is common but is often misdiagnosed, as symptoms may be perceived elsewhere. Shear and compressive forces in the lower cervical spine cause pain to be referred in such a way that the brain draws incorrect conclusions about the location of the injury.

Repeated strain, particularly during sleep, can delay recovery. Effective treatment requires reliable support of the lower cervical spine throughout the entire night – every night.

Healthy sleep is essential – it allows the body to recover from demanding days and promotes relaxation. If restorative sleep is not achieved, the consequences can be significant: tension headaches, inner restlessness, and reduced physical as well as mental performance.

Do not let it come to that. With a SISSEL Orthopaedic Pillow, you can enjoy restful and relaxed sleep again.

¹ Smythe, Hugh (1992): Neck Problems and Pain Referred from the Neck, Toronto 1992, https://sisself.com/downloads/study_neck_problems-pain_referred.pdf



Scan the QR code
to access the study

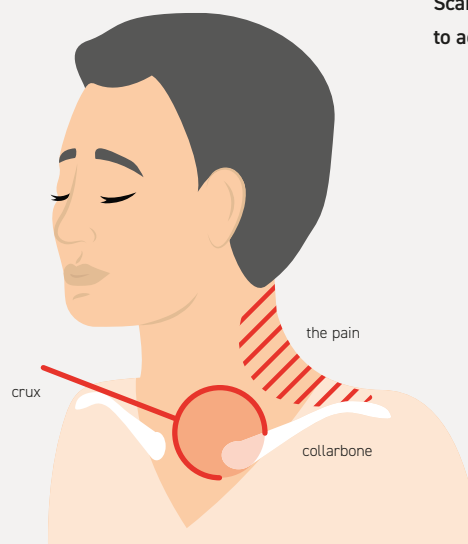

Actively Supportive Pillows

Orthopaedic neck pillows with actively supportive polyurethane foam

These pillows with active support are made from polyurethane foam, providing firm support and correct positioning in the neck and cervical spine area.

Recommended for:

- Neck and shoulder tension
- Tension headaches
- Helps prevent misalignment of the spine (in a side-lying position)

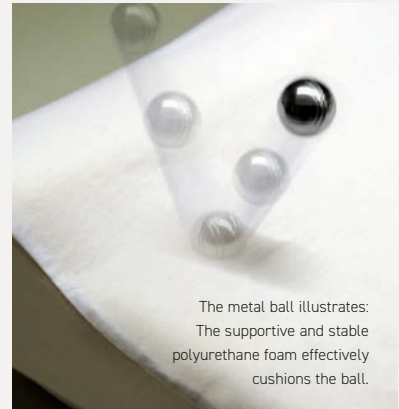

The metal ball illustrates: The supportive and stable polyurethane foam effectively cushions the ball.



SISSEL® Classic

Our standard orthopaedic neck pillow

- The proven SISSEL orthopaedic neck pillow, trusted millions of times
- Ideal for side and back sleepers
- Pillow core washable by hand
- Cover washable at 40 °C



For further information on the unique shape of this orthopaedic neck support pillow, see pages 100-101.

Item	Description
800013	SISSEL Classic, large, incl. pillow cover ecru
800016	SISSEL Classic, medium, incl. pillow cover ecru
800004	Extra pillow cover velours, ecru, size L
800005	Extra pillow cover velours, ecru, size M
800006	Extra pillow cover cotton, white, one size



M – approx. 47 x 33 x 11 cm,
L – approx. 47 x 33 x 14 cm



Cover: 75% cotton/25% polyester
Filling: polyurethane foam



ecru

SISSEL® Classic Plus

Height-adjustable orthopaedic neck pillow for different shoulder widths

- Height can be adjusted by inserting or removing the Vario Pad
- With a ventilation system for an optimal sleeping climate
- Ideal for side and back sleepers
- Thanks to its unique shape, this neck support pillow is particularly suitable for relieving pressure on the vertebrae and intervertebral discs of the cervical spine
- Pillow core washable by hand
- Cover washable at 40 °C



103

Ventilation system for an optimal sleeping climate. More than 90 ventilation channels help prevent heat build-up.

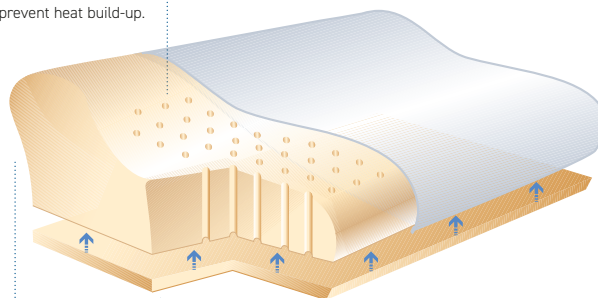

The unique contour of all SISSEL Orthopaedic Pillows ensures that the shoulder is optimally positioned even in a side-lying position, allowing the vertebrae and intervertebral discs to be relieved of pressure.

One pillow for everyone – adapts to shoulder width, neck length, and individual sleeping position thanks to the **Vario Pad**.



Item	Description
800003	SISSEL Classic Plus, incl. pillow cover ecru
800004	Extra pillow cover velours, ecru, size L
800006	Extra pillow cover cotton, white, one size



approx. 47 x 33 x 11/14 cm



Cover: 75% cotton/25% polyester
Filling: polyurethane foam



ecru

Pressure-relieving Pillows

Orthopaedic neck pillows made from viscoelastic foam



These pillows are made from a pressure-relieving viscoelastic foam that absorbs pressure and redistributes it evenly within the pillow core. Models with the additional designation 'Soft' are recommended in cases of acute discomfort and pressure-sensitive muscles.

Recommended for:

- Acute discomfort in the neck and cervical spine muscles
- Pressure-sensitive muscles
- Provides targeted support in cases of neck and neck-shoulder discomfort

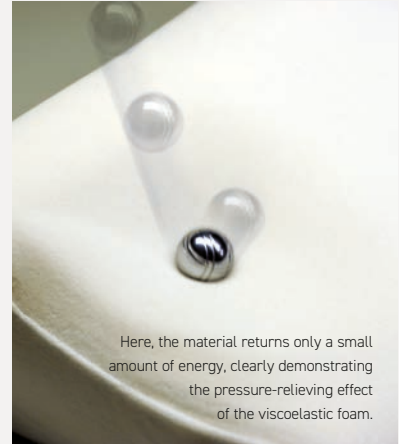

Here, the material returns only a small amount of energy, clearly demonstrating the pressure-relieving effect of the viscoelastic foam.

SISSEL® Soft

The softer neck pillow with gentle support

- Combines the benefits of the classic SISSEL orthopaedic pillow shape, proven millions of times, with the advantages of a viscoelastic foam filling
- The soft and highly adaptive material provides exceptional sleeping comfort, even for side and back sleepers with particularly sensitive necks
- The pillow adapts slowly and elastically to every shape
- No matter how the head and shoulders move during the night, the spine is always supported comfortably – softly yet stably
- Pillow core washable by hand
- Cover washable at 40 °C



Item	Description
800022	SISSEL Soft, size L, incl. pillow cover ecru
800031	SISSEL Soft, size M, incl. pillow cover ecru
800004	Extra pillow cover velours, ecru, size L
800005	Extra pillow cover velours, ecru, size M
800006	Extra pillow cover cotton, white, one size

 M – approx. 47 x 33 x 11 cm,
L – approx. 47 x 33 x 14 cm

 Cover: 75% cotton/25% polyester
Filling: viscoelastic foam

 ecru

SISSEL® Soft Plus

The softer, height-adjustable neck pillow with gentle support

- For more product information, see SISSEL Soft
- Height can be adjusted by inserting or removing the Vario Pad
- Pillow core washable by hand
- Cover washable at 40 °C

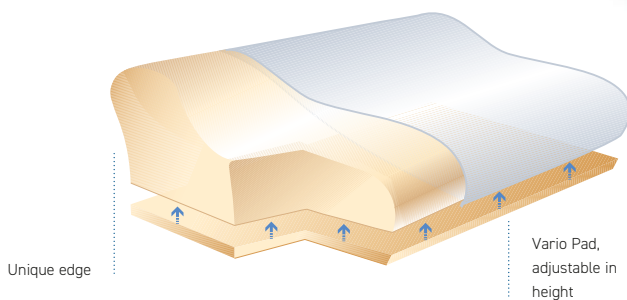

Item	Description
800032	SISSEL Soft Plus, incl. pillow cover ecru
800004	Extra pillow cover velours, ecru, size L
800006	Extra pillow cover cotton, white, one size

 approx. 47 x 33 x 11/14 cm

 Cover: 75% cotton/25% polyester
Filling: viscoelastic foam

 ecru

105

SISSEL® Soft Deluxe

The extra-wide, soft, and height-adjustable neck pillow

- 16 cm wider than the SISSEL Soft Plus
- Height can be adjusted by inserting or removing the Vario Pad
- Pillow core washable by hand
- Cover washable at 40 °C

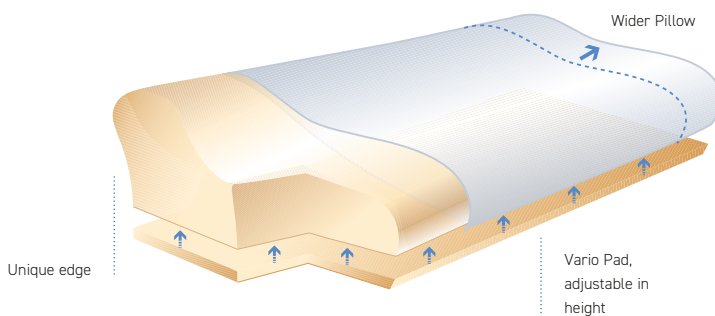

Item	Description
800009	SISSEL Soft Deluxe, incl. pillow cover
800010	Extra satin pillow cover, white

 approx. 63 x 33 x 10/12 cm

 Cover: satin, 50% cotton/50% polyester
Filling: viscoelastic foam

 white

SISSEL® Compact Pillow

Orthopaedic neck pillow in a compact format

- Pillow core washable by hand
- Cover washable at 40 °C

TIP Ideal for use on a therapy table



Item	Description
800025	SISSEL Compact Pillow, size approx. 37 x 25 x 9 cm

 approx. 37 x 25 x 9 cm

 Cover: 75% cotton/25% polyester
Filling: viscoelastic foam

 ecru

SISSEL® Soft Bambini

The Bambini version of the proven SISSEL Soft orthopaedic pillow

Give your child a calmer and more restful night. Our SISSEL orthopaedic neck pillow is the ideal choice for deep and restorative sleep. This ergonomically and orthopaedically designed pillow provides the optimal support your child needs.

- Suitable for children aged 4 years and above
- Supports a correct neck position for side and back sleepers
- Pillow core washable by hand
- Cover washable at 40 °C



Item	Description
800018	SISSEL Soft Bambini, incl. cover

 approx. 37 x 25 x 9 cm

 Cover: 100% cotton
Filling: viscoelastic foam

Sleep Pillows

Gently supportive pillows made from viscoelastic foam



The ideal choice for people with pressure sensitivity: on these gently supportive pillows, the head and neck are quite literally free from pressure. They adapt perfectly and provide a soft yet stable surface with a slightly lower corrective intensity than SISSEL Orthopaedic Pillows.

SISSEL® Soft Curve

The gently supportive pillow for particularly sensitive necks

- Pleasantly soft while providing stable support
- Ideal for back sleepers
- Compared to the orthopaedic SISSEL shape, the Soft Curve sleep pillow is characterised by its flatter and more rounded form, offering a gentler yet stable support
- Supports the neck and helps relieve pressure on the vertebrae and muscles
- Adapts optimally to the natural shape of the cervical spine
- High-quality viscoelastic foam, moulded in a single piece
- Durable and shape-retaining
- Pillow core washable by hand
- Cover washable at 40 °C



Item	Description
800049	SISSEL Soft Curve, size S, incl. cover velours, ecru
800052	SISSEL Soft Curve, size M, incl. cover velours, ecru
800054	SISSEL Soft Curve, size L, incl. cover velours, ecru
800057	SISSEL Soft Curve, Compact, incl. cover velours, ecru
800050	Extra pillow cover, size S, velours, ecru
800053	Extra pillow cover, size M, velours, ecru
800055	Extra pillow cover, size L, velours, ecru
800058	Extra pillow cover, Compact, velours, ecru

107



S approx. 63 x 30 x 8 cm, M approx. 63 x 32 x 10 cm,
L approx. 63 x 32 x 13 cm, Compact approx. 48 x 32 x 10 cm



Cover: 75% cotton/25% polyester
Filling: viscoelastic foam



ecru



Pillows with Natural Fillings

Experience healthy and comfortable sleep with our traditional pillows. Depending on your needs, we offer a range of different natural filling materials.



SISSEL® Palea

The breathable spelt husk pillow

- Adapts completely to the shape of the head and neck
- Helps maintain the natural alignment of the cervical spine
- Moisture- and heat-regulating
- Not washable



The benefits of spelt husk filling
Spelt husk is moisture-regulating and retains body heat, releasing it in a controlled and comfortable way. The pillow adapts to the shape of the head and neck, providing a pleasant yet stable form of support.

Item	Description
800040	SISSEL Palea, approx. 60 x 40 cm, without cover
800041	Cover SISSEL Palea, approx. 60 x 40 cm

approx. 60 x 40 cm

Cover: 100% cotton
Filling: 100% spelt filling

white



SISSEL® Panicore

The millet pillow – natural support for your cervical spine

- Adapts precisely to the shape of the head and neck, providing optimal support for the cervical spine
- Temperature-regulating and moisture-wicking
- Relaxing, with a gentle massaging effect
- Low-noise and low-dust
- Not washable



The benefits of millet husk filling
Millet husk is fine, soft, and pleasant to use, as it adapts to the shape of the body. Millet pillows are recommended for those who prefer to avoid the sound of rustling typical of spelt husk.

Item	Description
800046	SISSEL Panicore, approx. 60 x 40 cm, without cover

approx. 60 x 40 cm

Cover: 100% cotton
Filling: 100% millet

white



Travel Pillows

The perfect support on the go. With SISSEL travel pillows in a range of designs, the head and neck are always optimally supported – wherever you are travelling.



SISSEL® Buchi

The buckwheat-filled neck support

- Supports the neck during long and uncomfortable journeys by car, train, or aeroplane
- Ideal as a relaxing support when reading at home
- Adapts perfectly to the shape of the neck
- Cover washable at 40 °C



The benefits of buckwheat husk filling

Buckwheat husk is light, durable, and naturally cool – its key characteristics. The distinctly shaped hulls adapt to the body's contours, forming cushioned yet stable support for the head, neck, and shoulders.



Item	Description
800071	SISSEL Buchi, blue
800073	SISSEL Buchi, grey

109

 approx. 28 x 32 x 8 cm

 Cover: 100% polyester, lining 100% cotton
Filling: buckwheat

 available in 2 colours  



SISSEL® Buchi Soft

Travel in comfort – with the viscoelastic version of the SISSEL Buchi

- Optimal body adaptation thanks to two different angles of inclination
- High-quality, shape-retaining viscoelastic foam
- Comfortable and supportive at the same time
- Pillow core washable by hand
- Soft velour cover (blue/grey) with zipper, washable at 40 °C
- Includes a practical carry bag

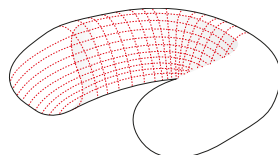



The pillow front is flatter for optimal anatomical comfort when lying on the side.

**NEW
Cover**



Item	Description
800074	SISSEL Buchi Soft, blue/grey
800677	SISSEL Buchi Soft, floral blue
800680	Extra cover, blue/grey
800681	Extra cover, floral blue

 approx. 25 x 26 x 7 cm

 Cover blue/grey: 75% cotton, 25% polyester
Cover floral blue: 92% cotton, 8% elasthane
Filling: viscoelastic foam

 available in 2 colours  

Positioning and Leg Support Cushions

Our positioning and leg support cushions provide optimal relaxation for tired and swollen legs. They offer not only excellent comfort, but also even pressure distribution.



SISSEL® Medi Support

Lie comfortably, enjoy restful sleep

- Easily secured to the legs with two comfortable hook-and-loop fasteners
- Reduces pressure on the knee joints
- Helps prevent unpleasant sweating
- Promotes an optimal lying position, reducing strain on the pelvis
- Cover washable at 40 °C



Item Number Attributes

800498	SISSEL Medi Support
800499	SISSEL Medi Support, extra cover, ecru



approx. 17 x 20 cm, 10 cm at the smallest part



Cover: 75% cotton / 25% polyester
Filling: polyurethane foam



ecru

SISSEL® Comfort



- Provides optimal support while ensuring comfort and even pressure distribution
- Excellent for positioning and care of older and bedridden individuals, as well as for positioning infants
- Relieves pressure on specific parts of the body when lying on the back or side, during or after pregnancy

Available with different fillings:

- **Polystyrene cushion** – microbeads allow the cushion to adapt particularly well; tested for harmful substances; machine-washable at 60 °C; with zip for refilling
- **Polypropylene cushion** – washable at 95 °C; with zip; no loss of volume thanks to the multiple shock resistance of the slightly larger beads



Cover incl. strap* – ideal for shaping a nest and for positioning the baby



NEW
Cover



Cotton covers 100% (washable at 40 °C)

- floral blue
- light blue
- white, grey dots, incl. strap*
- grey, white stars, incl. strap*



PU-cover: Polyurethane, blue (water-repellent)





Terry, white cover (75% cotton/25% polyester)



Item	Description
800483	SISSEL Comfort, filler material: polystyrene, without cover
800490	SISSEL Comfort, filler material: polypropylene, without cover
800486	Terry cover, white
800487	Cotton cover, light blue
800488	Cotton cover, grey/white stars*
800489	Cotton cover, white/grey dots*
800497	Cotton cover, floral blue
800494	Polyurethane cover, blue (water-repellent)

 approx. 195 x 35 cm

 Cover: cotton, velours or PU
Filling: polystyrene or PP

 Available in 6 different designs.



112

SISSEL® Venosoft

Combines the excellent properties of a leg support cushion with a viscoelastic top layer

- The integrated top layer, thanks to its softness, provides optimal pressure relief and enables effective and relaxing leg elevation
- Supports venous return and, thanks to its ergonomic shape, may help relieve the lower back
- Cover washable at 40 °C

YouTube



Item	Description
800141	SISSEL Venosoft, approx. 65 x 50 x 22 cm, incl. Velours cover, ecru
800143	SISSEL Venosoft, approx. 78 x 50 x 22 cm, incl. Velours cover, ecru
800146	Velours cover for Venosoft small, ecru
800147	Velours cover for Venosoft large, ecru



available in 2 sizes:
 approx. 65 x 50 x 22 cm, height up to 165 cm
 approx. 78 x 50 x 22 cm, starting height 165 cm



Cover: 75% cotton / 25% polyester
 Filling: polyurethane foam / viscoelastic foam layer



ecru

SISSEL® Venosoft Balance

NEW



The comfortable leg elevation cushion made from sustainable composite foam

- The integrated top layer, thanks to its softness, provides optimal pressure relief and enables effective, relaxing leg elevation
- The Venosoft Balance is a relaxation aid that supports venous return and, thanks to its ergonomic shape, may help relieve the lower back
- Comfortable special top layer for maximum lying comfort
- Adjustable foam wedge allows for versatile positioning options
- Stable foam core



Item	Description
800813	SISSEL Venosoft Balance, incl. cover, small
800814	SISSEL Venosoft Balance, incl. cover, large



available in 2 sizes:

Size small: approx. 65 x 50 x 22 cm, max. user height: 165 cm
Size large: approx. 78 x 50 x 22 cm, min. user height: 165 cm



Cover: 80% cotton, 20% polyester
Filling: rebonded polyurethane foam & polyurethane foam layer



grey

113

SISSEL® Veno



Blissful relaxation for tired and swollen legs

- Perfectly supports leg elevation or relaxation
- Use to ease swollen legs, congestions and during pregnancy
- Cover washable at 40 °C



Item	Description
800148	SISSEL Veno, incl. cover – as long as stock lasts



approx. 66.5 x 40 x 16 cm



Cover: 75% cotton / 25% polyester
Filling: flexible polyurethane foam (PUR)



ecru



The natural way

